

Multi-family Price Book 5

Effective August 2017 - Rev. 12/18



Schlage Residential Locks (continued)

B - Lock

Function	Description	Lever Style	Finish	Latch	Strike	Cylinder	Price Each
B60	Deadbolt	SGL CYL	619	12-321	10-116	5 Pin C Keyway KA4	\$62.00
B60	Deadbolt	SGL CYL	622	12-321	10-116	5 Pin C Keyway KA4	62.00
B60	Deadbolt	SGL CYL	625	12-321	10-116	5 Pin C Keyway KA4	62.00
B60	Deadbolt	SGL CYL	626	12-321	10-116	5 Pin C Keyway KA4	62.00
B60	Deadbolt	SGL CYL	716	12-321	10-116	5 Pin C Keyway KA4	62.00



Dover (DOV)



Marin (MAR)



Solstice (SOL)



Solstice (SOL)
Collins Rose



Broadway (BRW)



Broadway (BRW)
Collins Rose

Residential J Series

J - Lock

Function	Description	Lever Style	Finish	Latch	Strike	Cylinder	Price Each
J10	Passage	SOL	619	16-254	10-101	N/A	\$42.00
J40	Privacy	SOL	619	16-254	10-101	N/A	45.00
J170	Dummy	SOL	619	N/A	N/A	N/A	22.00
J10	Passage	SOL	622	16-254	10-101	N/A	42.00
J40	Privacy	SOL	622	16-254	10-101	N/A	45.00
J170	Dummy	SOL	622	N/A	N/A	N/A	22.00
J10	Passage	SOL	625	16-254	10-101	N/A	42.00
J40	Privacy	SOL	625	16-254	10-101	N/A	45.00
J170	Dummy	SOL	625	N/A	N/A	N/A	22.00
J10	Passage	SOL	626	16-254	10-101	N/A	42.00
J40	Privacy	SOL	626	16-254	10-101	N/A	45.00
J170	Dummy	SOL	626	N/A	N/A	N/A	22.00
J10	Passage	SOL	716	16-254	10-101	N/A	42.00
J40	Privacy	SOL	716	16-254	10-101	N/A	45.00
J170	Dummy	SOL	716	N/A	N/A	N/A	22.00
J10	Passage	SOL/COL	619	16-254	10-101	N/A	47.00
J40	Privacy	SOL/COL	619	16-254	10-101	N/A	50.00
J170	Dummy	SOL/COL	619	N/A	N/A	N/A	25.00
J10	Passage	SOL/COL	622	16-254	10-101	N/A	47.00
J40	Privacy	SOL/COL	622	16-254	10-101	N/A	50.00
J170	Dummy	SOL/COL	622	N/A	N/A	N/A	25.00
J10	Passage	SOL/COL	625	16-254	10-101	N/A	47.00
J40	Privacy	SOL/COL	625	16-254	10-101	N/A	50.00
J170	Dummy	SOL/COL	625	N/A	N/A	N/A	25.00
J10	Passage	SOL/COL	626	16-254	10-101	N/A	47.00
J40	Privacy	SOL/COL	626	16-254	10-101	N/A	50.00
J170	Dummy	SOL/COL	626	N/A	N/A	N/A	25.00
J10	Passage	SOL/COL	716	16-254	10-101	N/A	47.00
J40	Privacy	SOL/COL	716	16-254	10-101	N/A	50.00
J170	Dummy	SOL/COL	716	N/A	N/A	N/A	25.00
J10	Passage	BRW	619	16-254	10-101	N/A	42.00
J40	Privacy	BRW	619	16-254	10-101	N/A	45.00
J170	Dummy	BRW	619	N/A	N/A	N/A	22.00
J10	Passage	BRW	622	16-254	10-101	N/A	42.00
J40	Privacy	BRW	622	16-254	10-101	N/A	45.00
J170	Dummy	BRW	622	N/A	N/A	N/A	22.00
J10	Passage	BRW	625	16-254	10-101	N/A	42.00
J40	Privacy	BRW	625	16-254	10-101	N/A	45.00
J170	Dummy	BRW	625	N/A	N/A	N/A	22.00
J10	Passage	BRW	626	16-254	10-101	N/A	42.00
J40	Privacy	BRW	626	16-254	10-101	N/A	45.00
J170	Dummy	BRW	626	N/A	N/A	N/A	22.00
J10	Passage	BRW	716	16-254	10-101	N/A	42.00
J40	Privacy	BRW	716	16-254	10-101	N/A	45.00
J170	Dummy	BRW	716	N/A	N/A	N/A	22.00
J10	Passage	BRW/COL	619	16-254	10-101	N/A	47.00
J40	Privacy	BRW/COL	619	16-254	10-101	N/A	50.00



Schlage Residential Locks (continued)

Residential J Series
J - Lock (continued)

Function	Description	Lever Style	Finish	Latch	Strike	Cylinder	Price Each
J170	Dummy	BRW/COL	619	N/A	N/A	N/A	25.00
J10	Passage	BRW/COL	622	16-254	10-101	N/A	47.00
J40	Privacy	BRW/COL	622	16-254	10-101	N/A	50.00
J170	Dummy	BRW/COL	622	N/A	N/A	N/A	25.00
J10	Passage	BRW/COL	625	16-254	10-101	N/A	47.00
J40	Privacy	BRW/COL	625	16-254	10-101	N/A	50.00
J170	Dummy	BRW/COL	625	N/A	N/A	N/A	25.00
J10	Passage	BRW/COL	626	16-254	10-101	N/A	47.00
J40	Privacy	BRW/COL	626	16-254	10-101	N/A	50.00
J170	Dummy	BRW/COL	626	N/A	N/A	N/A	25.00
J10	Passage	BRW/COL	716	16-254	10-101	N/A	47.00
J40	Privacy	BRW/COL	716	16-254	10-101	N/A	50.00
J170	Dummy	BRW/COL	716	N/A	N/A	N/A	25.00
J10	Passage	MAR	619	16-254	10-101	N/A	38.00
J40	Privacy	MAR	619	16-254	10-101	N/A	41.00
J170	Dummy	MAR	619	N/A	N/A	N/A	20.00
J10	Passage	MAR	622	16-254	10-101	N/A	38.00
J40	Privacy	MAR	622	16-254	10-101	N/A	41.00
J170	Dummy	MAR	622	N/A	N/A	N/A	20.00
J10	Passage	MAR	625	16-254	10-101	N/A	38.00
J40	Privacy	MAR	625	16-254	10-101	N/A	41.00
J170	Dummy	MAR	625	N/A	N/A	N/A	20.00
J10	Passage	MAR	626	16-254	10-101	N/A	38.00
J40	Privacy	MAR	626	16-254	10-101	N/A	41.00
J170	Dummy	MAR	626	N/A	N/A	N/A	20.00
J10	Passage	MAR	716	16-254	10-101	N/A	38.00
J40	Privacy	MAR	716	16-254	10-101	N/A	41.00
J170	Dummy	MAR	716	N/A	N/A	N/A	20.00
J10	Passage	DOV	619	16-254	10-101	N/A	38.00
J40	Privacy	DOV	619	16-254	10-101	N/A	41.00
J170	Dummy	DOV	619	N/A	N/A	N/A	20.00
J10	Passage	DOV	622	16-254	10-101	N/A	38.00
J40	Privacy	DOV	622	16-254	10-101	N/A	41.00
J170	Dummy	DOV	622	N/A	N/A	N/A	20.00
J10	Passage	DOV	625	16-254	10-101	N/A	38.00
J40	Privacy	DOV	625	16-254	10-101	N/A	41.00
J170	Dummy	DOV	625	N/A	N/A	N/A	20.00
J10	Passage	DOV	626	16-254	10-101	N/A	38.00
J40	Privacy	DOV	626	16-254	10-101	N/A	41.00
J170	Dummy	DOV	626	N/A	N/A	N/A	20.00
J10	Passage	DOV	716	16-254	10-101	N/A	38.00
J40	Privacy	DOV	716	16-254	10-101	N/A	41.00
J170	Dummy	DOV	716	N/A	N/A	N/A	20.00
JD60	Deadbolt	SGL CYL	619	16-068	10-267	5 Pin C Keyway KA4	32.00
JD60	Deadbolt	SGL CYL	622	16-068	10-267	5 Pin C Keyway KA4	32.00
JD60	Deadbolt	SGL CYL	625	16-068	10-267	5 Pin C Keyway KA4	32.00
JD60	Deadbolt	SGL CYL	626	16-068	10-267	5 Pin C Keyway KA4	32.00
JD60	Deadbolt	SGL CYL	716	16-068	10-267	5 Pin C Keyway KA4	32.00



B Series Deadbolts

B Series Deadbolts

FINISHES

Function	Packaging	605	505	608	609	618	619	620	621	622	625	626	716	613
B60 Single Cylinder	Box/Vis	\$56	\$62	\$62	\$62	\$62	\$62	\$62	\$62	\$62	\$62	\$62	\$62	\$71
B62 Double Cylinder	Box/Vis	81	87	87	87	87	87	87	87	87	87	87	87	96
B80 One-sided	Box	38	▪	44	44	44	44	44	44	44	44	44	44	53
B81 One-sided w/trim	Box	40	47	47	47	47	47	47	47	47	47	47	47	55
B60R6 Single Cylinder Interchgl. Core-6 Pin	Box	▪	161	▪	▪	▪	159	▪	▪	▪	▪	159	161	▪

List Price Adders:

UL Latch - add \$6 to list price (B60, B80, B81 and B60R6)

J Series Deadbolts

J Series Deadbolts

FINISHES

Function	Packaging	605	609	619	625	626	630	620	716
JD60 Single Cylinder Deadbolt	Box	\$32	\$32	\$32	\$32	\$32	\$32	\$32	\$32
JD80 One-Sided Cylinder Deadbolt	Box	28	28	28	▪	▪	▪	28	28
JD81 One-Sided Deadbolt with trim	Box	28	28	28	▪	▪	▪	28	▪
JD60F Single Cylinder UL Version	Box	38	38	38	38	38	38	38	38
JD60 Single Cylinder Deadbolt	Vis	35	35	35	▪	▪	▪	35	35
JD62 Double Cylinder Deadbolt	Vis	45	45	45	▪	▪	▪	45	45

Exits

Von Duprin 22 Series

- UL listed for Panic Exit Hardware
- Devices are ANSI A156.3, 2001 Grade 1 Certified
- Two finishes available: **SP28** = Powder-coated aluminum **SP313** = Powder-coated dark bronze

22 Rim Panic Device

Trim Function	Handing	Finish	Series	3'	4'
				List Price	
Exit Only	-	SP28	22-EO-SP28	\$465.00	\$476.00
Exit Only	-	SP313	22-EO-SP313	\$465.00	\$476.00

22-F Rim Fire Exit Hardware

Trim Function	Handing	Finish	Series	3'	4'
				List Price	
Exit Only	-	SP28	22-EO-F-SP28	\$578.00	\$589.00
Exit Only	-	SP313	22-EO-F-SP313	\$578.00	\$589.00

2227 Surface Vertical Rod Panic Device

Trim Function	Handing	Finish	Series	Door Height	3'	4'
					List Price	
Exit Only	-	SP28	2227-EO-SP28	7'	\$803.00	\$814.00
Exit Only	-	SP313	2227-EO-SP313	7'	\$803.00	\$814.00

2227-F Surface Vertical Rod Fire Exit Hardware

Trim Function	Handing	Finish	Series	Door Height	3'	4'
					List Price	
Exit Only	-	SP28	2227-EO-F-SP28	7'	\$1,030.00	\$1,041.00
Exit Only	-	SP313	2227-EO-F-SP313	7'	\$1,030.00	\$1,041.00

Auxiliary Parts

Cylinders

Model No.	Description	Compatible Trim Series	Finish	List Price
3215	Mortise 1 1/4"	230L	US26D	\$86.00
3216	Rim Cylinder	210NL, 230NL	US26D	86.00

Extension Rods

Model No.	Description	Finish	List Price
ER-22	36" Extension Rod for 2227	SP28	\$28.00
ER-22	36" Extension Rod for 2227	SP313	28.00

Sex Bolts

Model No.	Description	Finish	List Price
325	325 Sex Bolt 1/4 - 20 (pkg of 2)		\$24.00
425	425 Sex Bolt 10-24 (Pkg of 2)		24.00

Electronics e-Strike**Electronics e-Strike**

Description	Finish	Price Each
4211-US32D-12/24VDC-FSA/FSE	630	\$187.00
4212-US32D-12/24VDC-FSA/FSE	630	225.00
6111 US32D 24VDC FSE	630	841.00
6112 US32D 24VDC FSE	630	787.00
6210 US32D 24VDC FSE	630	766.00
6210 US32D 12VDC FSE	630	766.00
6210 US32D 24VDC FSE DS	630	957.00
6210 US32D 24VDC FS	630	805.00
6211 FSE (MORT/CYL) 24VDC 630	630	722.00
6211 FSE 12VDC ELEC STRIKE	630	722.00
6211 FSE DS (MORT/CYL) 630	630	913.00
6211 US32D 24VDC FS	630	761.00
6211 US32D 24VDC FSE	630	722.00
6211AL US32D 24VDC FSE	630	750.00
6211WF US32D 24VDC FSE	630	730.00
6212 US32D 24VDC FSE	630	855.00
6223 FSE 24VDC ELEC STRIKE	630	805.00
5100 3FP 689 24VDC	689	243.00
6300 US32D 12/24VDC FSE	630	723.00
6400 US32D 12/24VDC FSE	630	509.00

Von Duprin Exit Devices

98 Series

- 3' Devices are priced complete with standard trim and strike(s).
- 4' add \$18 list.

		US26D	US26	US15	643E	315
EXIT HARDWARE						
98EO	Rim Device	\$1,356.00	\$1,579.00	\$1,579.00	\$1,579.00	\$1,936.00
9827EO	Surface Vertical Rod Device	1,960.00	2,237.00	2,237.00	2,237.00	2,616.00
9849EO	Concealed Vertical Cable Device	2,077.00	2,275.00	2,275.00	2,275.00	2,698.00

FIRE EXIT HARDWARE

98EO-F	Rim Device	\$1,510.00	\$1,781.00	\$1,781.00	\$1,781.00	\$2,159.00
9827EO-F	Surface Vertical Rod Device	2,228.00	2,540.00	2,540.00	2,540.00	2,882.00
9849EO-F	Concealed Vertical Cable Device	2,253.00	2,451.00	2,451.00	2,451.00	2,874.00

Von Duprin 35A Series

- 3' Devices are priced complete with standard trim and strike(s).
- 4' add \$18 list.

		US26D	US26	US15	643E	315
EXIT HARDWARE						
35A-EO	Rim Device	\$1,673.00	\$1,753.00	\$1,753.00	\$1,753.00	\$2,107.00
3549A-EO	Concealed Vertical Cable Device	2,393.00	2,480.00	2,480.00	2,480.00	2,916.00

FIRE EXIT HARDWARE

35A-EO-F	Rim Device	1,775.00	1,855.00	1,855.00	1,855.00	2,209.00
3549A-EO-F	Concealed Vertical Cable Device	2,498.00	2,585.00	2,585.00	2,585.00	3,021.00

Concealed Vertical Cable (CVC) Reference:

Nominal Door Opening Height

72"-82"	6' - 6'10"
* >82"-96"	* >6'10" - 8'
>96" -110"	>8' - 9'2"
>110" -120"	>9'2"-10'

* Default Door Opening Height. Specify height if other than default.

Device Options**Dogging Option**

Prefix		List Add
LD	Less Dogging	\$44.00

Weep Holes

Suffix		List Add
WH	Drainage (Weep) Holes in Mechanism Case	\$86.00
	3' device will have 5 holes - 6" spacing, 4' device will have 7 holes - 6" spacing	

Switches

Prefix		List Add
RX	Request to Exit - available on all 35A and 98 Series Devices	\$242.00

Electric Latch Retraction

Prefix		List Add
QEL	Quiet Electric Latch Retraction - available on all 35A and 98 Series Devices	\$887.00

Electric Unlocking

		List Add
E996	Electric Unlocking of outside E996 Trim - for 98 devices	\$599.00
	Available with L or LBE functions only. Specify handing.	
	Specify FAIL SECURE (FSE) or FAIL SAFE (FS).	

Allegion Connect

Suffix		List Add
CON	Cross-category solution using common interconnect components for electrified options. Available with RX switches, QEL, and E996.	N/C

NOTE: For wire harness options refer to Power Supply and Electronic Component Section.

Device Accessories

Dummy Touch Bars

- 3' Devices are priced complete with sex bolts.
- 4' add \$18 list.

Model No.	Description	US26D	US26	US15	643E	315
350	35A/98 series device dummy touch bar	\$776.00	\$776.00	\$776.00	\$776.00	\$1,410.00

98 Series Trim

Specify device type when ordering (example: 996L-R)

Model No.	Description	Device Type	US26D	US26	US15	643E	SPLBLK
110MD-NL	Night Latch Cyl. Assy, MD Dr	-	\$125.00	\$127.00	\$127.00	\$127.00	\$127.00
996L	Lever	R&V	572.00	667.00	667.00	667.00	587.00
996L-BE	Lever, Blank Escutcheon	R&V	572.00	667.00	667.00	667.00	587.00
996L-NL	Lever, Night Latch	R&V	445.00	533.00	533.00	533.00	460.00

Lever Designs

Model No.	Description
Standard	06 Lever Design - furnished standard.
	Optional Lever Designs - Latitude (LAT),17, 07
Handing	Field reversible and furnished RHR if not specified

35A Series Trim

Model No.	Description	US26D	US26	US15	643E	315
388 (NL-OP)	Night Latch Cylinder Trim	\$293.00	\$293.00	\$293.00	\$293.00	\$293.00

Power Transfer

Model No.	Description	SP28
EPT10	Ten 24 guage wires	\$484.00
EPT10 CON	Ten 24 guage wires with connectors	\$495.00

24-R Device Series

3' Devices are priced with standard trim and strikes, 4' add \$19 list.
Cylinders are not included in the price.

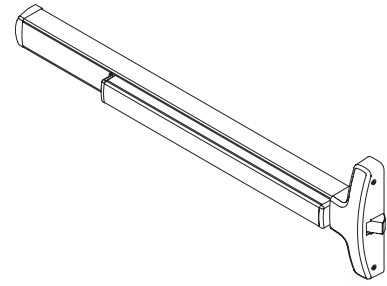

EXIT HARDWARE

Rim Devices

(Includes 299 Strike)

	Trim/Control	US19* US26D	US26	US11* US15*
* 24-R-EO		1325	1375	1497
* 24-R-NL-OP (Supplied as NL less trim)		1325	1375	1497
Delta Trim (handed and field reversible)				
24-R-DT	717DT	1574	1624	1746
24-R-DT	718DT	1593	1643	1765
* 24-R-NL	718NL*	1574	1624	1746
* 24-R-C	718C*	1516	1566	1688
Knob Control (handed and field reversible)				
24-R-K	711K	1622	1672	1794
24-R-K-BE	711K-BE	1622	1672	1794
24-R-K-NL	711K-NL	1622	1672	1794
Dane Lever Control (handed and field reversible)				
* 24-R-L	712L*	1691	1741	1863
* 24-R-L-BE	712L-BE*	1691	1741	1863
* 24-R-L-NL	712L-NL*	1691	1741	1863
* 24-R-L-DT	712L-DT*	1691	1741	1863

* These devices and 712L, 712L-BE, 712L-NL, 712L-DT, 718C, 718NL trims are available in US11, US15 and US19 finishes.

24 Series ordered in 313AN will be supplied with trims in SP313.

Handing: Trims are furnished RHR when handing is not specified.

24 Rim, comes with dead latching as a standard effective April 3, 2017.

Sex Bolts:

Optional Sex Bolts are recommended for center case mounting when device is used with hollow core wood, composite or light gauge hollow metal doors. See chart below for quantities and list prices.

Application	Sex Bolt 325 (Optional)	Sex Bolt 425 (Optional)	List Add
Hollow core wood, composite or light gauge hollow metal doors - EO (exit only device)	2	4	72
Hollow core wood, composite or light gauge hollow metal doors - Device with Trim	Not Required	4	48

F-24-R Device Series

3' Devices are priced with standard trim and strikes, 4' add \$19 list.
Cylinders are not included in the price.

EXIT HARDWARE

Rim Devices

(Includes 299F Strike)

	Trim/Control	US19* US26D	US26	US11* US15*
* F-24-R-EO		1528	1578	1700
* F-24-R-NL-OP (Supplied as NL less trim)		1528	1578	1700
Delta Trim (handed and field reversible)				
F-24-R-DT	717DT	1777	1827	1949
F-24-R-DT	718DT	1796	1846	1968
* F-24-R-NL	718NL*	1777	1827	1949
* F-24-R-C	718C*	1719	1769	1891
Knob Control (handed and field reversible)				
F-24-R-K	711K	1825	1875	1997
F-24-R-K-BE	711K-BE	1825	1875	1997
F-24-R-K-NL	711K-NL	1825	1875	1997
Dane Lever Control (handed and field reversible)				
* F-24-R-L	712L*	1894	1944	2066
* F-24-R-L-BE	712L-BE*	1894	1944	2066
* F-24-R-L-NL	712L-NL*	1894	1944	2066
* F-24-R-L-DT	712L-DT*	1894	1944	2066

* These devices and 712L, 712L-BE, 712L-NL, 712L-DT, 718C, 718NL trims are available in US11, US15 and US19 finishes.

24 Series ordered in 313AN will be supplied with trims in SP313.

Handing: Trims are furnished RHR when handing is not specified.

Sex Bolts:

Sex Bolts are supplied for center case mounting when device is used with wood, composite or non-reinforced hollow metal doors.

Application	Sex Bolt 325 (Optional)	Sex Bolt 425 (Optional)
Wood, composite or non-reinforced hollow metal doors - EO (exit only device)	2	4
Wood, composite or non-reinforced hollow metal doors - Device with Trim	Not Required	4

24-V Device Series**3' Devices are priced with standard trim and strikes, 4' add \$19, 2' add \$123 list.****Cylinders are not included in the price.****EXIT HARDWARE****Surface Vertical Rod Devices**

(Includes 3788 and 2130 Strikes)

	Trim/Control	US19* US26D	US26	US11* US15*
* 24-V-EO		1739	1807	1949
* 24-V-NL-OP (Supplied as NL less trim)		1739	1807	1949
Delta Trim (handed and field reversible)				
24-V-DT	717DT	1988	2056	2198
24-V-DT	718DT	2007	2075	2217
* 24-V-NL	718NL*	1988	2056	2198
* 24-V-C	718C*	1930	1998	2140
Knob Control (handed and field reversible)				
24-V-K	711K	2036	2104	2246
24-V-K-BE	711K-BE	2036	2104	2246
24-V-K-NL	711K-NL	2036	2104	2246
Dane Lever Control (handed and field reversible)				
* 24-V-L	712L*	2105	2173	2315
* 24-V-L-BE	712L-BE*	2105	2173	2315
* 24-V-L-NL	712L-NL*	2105	2173	2315
* 24-V-L-DT	712L-DT*	2105	2173	2315

* These devices and 712L, 712L-BE, 712L-NL, 712L-DT, 718C, 718NL trims are available in US11, US15 and US19 finishes.

Handing: 24-V devices and noted Trims are handed and field reversible. The Device and Trims are furnished RHR when handing is not specified.**Extension Rods:** For door heights over 7'0" up to 8'0", 12" extension rods are furnished at no additional charge at the time of device order. For door heights over 8'0" up to 10'0" extension rods are furnished at prices shown in parts section with the device at the time of order.

MUST specify door height on order line.

Sex Bolts:

Optional Sex Bolts are recommended for center case and latch mounting when device is used with hollow core wood, composite or light gauge hollow metal doors. See chart below for quantities and list prices.

Application	Latches Sex Bolt 2729 (Optional)	Device Sex Bolt 425 (Optional)	Device Sex Bolt 325 (Optional)	List Add
Hollow core wood, composite or light gauge hollow metal doors - EO (exit only device)	6	2	2	102.00
Hollow core wood, composite or light gauge hollow metal doors - Device with Trim	6	2	Not Required	78.00
Hollow core wood, composite or light gauge hollow metal doors - EO (exit only device) LBR	3	2	2	75.00
Hollow core wood, composite or light gauge hollow metal doors - Device with Trim LBR	3	2	Not Required	51.00

F-24-V Device Series

3' Devices are priced with standard trim and strikes, 4' add \$19, 2' add \$123 list.
Cylinders are not included in the price.

FIRE EXIT HARDWARE
Surface Vertical Rod Devices
 (Includes 3788 and 2130 Strikes)

Trim/Control		US19*	US26D	US26	US11*	US15*
* F-24-V-EO		1926		1994		2136
* F-24-V-NL-OP (Supplied as NL less trim)		1926		1994		2136
Delta Trim (handed and field reversible)						
F-24-V-DT	717DT	2175		2243		2385
F-24-V-DT	718DT	2194		2262		2404
* F-24-V-NL	718NL*	2175		2243		2385
* F-24-V-C	718C*	2117		2185		2327
Knob Control (handed and field reversible)						
F-24-V-K	711K	2223		2291		2433
F-24-V-K-BE	711K-BE	2223		2291		2433
F-24-V-K-NL	711K-NL	2223		2291		2433
Dane Lever Control (handed and field reversible)						
* F-24-V-L	712L*	2292		2360		2502
* F-24-V-L-BE	712L-BE*	2292		2360		2502
* F-24-V-L-NL	712L-NL*	2292		2360		2502
* F-24-V-L-DT	712L-DT*	2292		2360		2502

* These devices and 712L, 712L-BE, 712L-NL, 712L-DT, 718C, 718NL trims are available in US11, US15 and US19 finishes.
Extension Rods: For door heights over 7'0" up to 8'0", 12" extension rods are furnished at no additional charge at the time of device order.
 For door heights over 8'0" up to 10'0" extension rods are furnished at prices shown in parts section with the device at the time of order.
 MUST specify door height on order line.

Sex Bolts:

One 4122 Sex Bolt is supplied standard no charge for hinge side mounting. Sex Bolts are supplied for center case and latch mounting when device is used with wood, composite or non-reinforced hollow metal doors.

Application	Latches Sex Bolt 2729 (Supplied)	Device Sex Bolt 425 (Supplied)	Device Sex Bolt 325 (Supplied)
Wood, composite or non-reinforced hollow metal doors - EO (exit only device)	6	2	2
Wood, composite or non-reinforced hollow metal doors - Device with Trim	6	2	Not Required
Wood, composite or non-reinforced hollow metal doors - EO (exit only device) LBR	3	2	2
Wood, composite or non-reinforced hollow metal doors - Device with Trim LBR	3	2	Not Required

24 Device Options

Cylinder Dogging

Not for use with Fire Exit Hardware

Prefix		List Add
CD	Cylinder Dogging available on all 24 series Panic Devices.	60
LD	Less Dogging available on all 24 series Panic Devices.	27

Less Bottom Rod

Suffix		List Add
LBR	Less Bottom Rod available with UL Fire Label at no additional charge on F-24-V and F-24-C devices. Fire rated LBR devices must be ordered in pairs of Vertical Rod Devices. For Fire Rated Devices specify one device LBR and second device LBR-AFL. Second device provided with a Fire Pin.	N/C

Electric Latch Retraction

Prefix		List Add
EL	Electric Latch Retraction - Available on all 24 series Panic and Fire Devices. Electrical Latch cannot be used in combination with CD, EA or KOR options.	513

REFERENCE NOTE:

PS914 is required for EL operation. See Power Supply section for more detail.

Device Monitoring

Prefix		List Add
RX	Touch Bar Request to Exit Switch available on all 24 series devices. RX device monitoring switch can be used in combination with a DM or LM switch (except for 24-R panic and fire).	195
KOR	Key Override - Override device monitoring on a door by use of a keyed cylinder. KOR must be used in combination with a device monitoring switch.	54

Exit Alarm

Prefix		List Add
EA	Exit Alarm available on 24-R and 24-V Panic and Fire Devices. Price includes switch - "RX" is standard, "LM" is optional at no charge. To order "Less Switch", Deduct \$195 list.	483

Allegion Connect

Suffix		List Add
CON	Cross-category solution using common interconnect components for electrified options. Available with EL, RX, DM, LM, EA, RX-DM, RX-LM, EL-RX, EL-DM, EL-LM options.	N/C

NOTE: For wire harness options refer to Power Supply and Electronic Component Section.

24 Series Trim

Cylinders are not included in price unless noted.

Athena Trim

Model No.	Device Type	Description	US15	US26 US26D
715DT	R, V	Dummy Trim	-	220

Control Trim

Model No.	Device Type	Description	US15	US26 US26D
711K	R, V	Knob, Key Locks or Unlocks	297	297
711K	C	Knob, Key Locks or Unlocks	297	297
711K-BE	R, V	Knob, Blank Escutcheon	297	297
711K-BE	C	Knob, Blank Escutcheon	297	297
711K-NL	R, V	Knob, Night Latch	297	297
711K-NL	C	Knob, Night Latch	297	297

711 series trim are handed and field reversible. Trims are furnished RHR when handing is not specified.

Delta Controls

Model No.	Device Type	Description	US32D	US26 US26D
717DT	R, V	Dummy Trim	249	249
717DT	C	Dummy Trim	249	249

717 series trim are handed and field reversible. Trims are furnished RHR when handing is not specified.

Delta Controls

Model No.	Device Type	Description	US15	US11* US26 US19* US26D
718DT	C	Dummy Trim	268	268
718NL*	R, V	Night Latch	249	249
718NL*	C	Night Latch	249	249
718C*	R, V	Night Latch Less Pull	191	191
718C*	C	Night Latch Less Pull	191	191
718TL	C	Turn Lever	544	544
718TL-BE	C	Turn Lever - Blank Escutcheon	564	564

* Available in US11 and US19.

718 series trim are handed and field reversible. Trims are furnished RHR when handing is not specified.

Control Lever Trims

Model No.	Device Type	Description	US15	US11* US26 US19* US26D
712L*	R, V	Dane Lever, Key Locks or Unlocks	366	366
712L*	C	Dane Lever, Key Locks or Unlocks	366	366
712L-BE*	R, V	Dane Lever, Blank Escutcheon	366	366
712L-BE*	C	Dane Lever, Blank Escutcheon	366	366
712L-NL*	R, V	Dane Lever, Night Latch	366	366
712L-NL*	C	Dane Lever, Night Latch	366	366
712L-DT*	R, V	Dane Lever, Dummy Trim	366	366
712L-DT*	C	Dane Lever, Dummy Trim	366	366

* Available in US11 and US19.

712 series trim are handed and field reversible. Trims are furnished RHR when handing is not specified.

The Dane Lever is furnished standard. Optional lever designs Sutor, Quantum and Avalon are available at no additional charge.

24 Series ordered in US32D will be supplied with trims in US15.

25 Device Series

3' Devices are priced with standard trim and strike, 4' add \$19 list.
Cylinders are not included in the price.

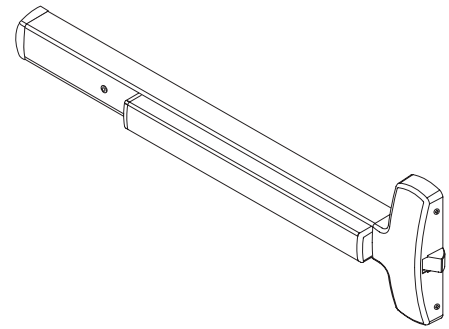

EXIT HARDWARE

Rim Devices

(Price includes 299 Strike)

	Trim/Control	US19* US26D	US26	US11* US15*
* 25-R-EO		1028	1070	1203
* 25-R-NL-OP (Supplied as NL less trim)		1028	1070	1203
Lever - Dane (handed and field reversible)				
* 25-R-L	510L*	1400	1448	1581
* 25-R-L-BE	510L-BE*	1400	1448	1581
* 25-R-L-NL	510L-NL*	1325	1417	1550
* 25-R-L-DT	510L-DT*	1325	1417	1550
VR Lever (handed and field reversible)				
* 25-R-L	511L*	1452	1503	1636
Thumbpiece (non-handed)				
25-R-TP	512TP	1339	1435	1568
25-R-TP-BE	512TP-BE	1339	1435	1568
* 25-R-NL	512-NL*	1277	1364	1497
Knob (non-handed)				
25-R-K	513K	1306	1396	1529
25-R-K-BE	513K-BE	1306	1396	1529
25-R-K-NL	513K-NL	1306	1396	1529
25-R-K-DT	513K-DT	1306	1396	1529
DT Pull (717 handed and field reversible, 512 non-handed)				
25-R-DT	717DT	1277	1319	1452
25-R-DT	512DT	1222	1364	1497

* These devices and 510L, 510L-BE, 510L-NL, 510L-DT, 511L, 512NL trims are available in US11, US15, and US19 finishes.

Handing: 25-R Device is non-handed. Trims are furnished RHR when handing is not specified.

Sex Bolts:

Optional Sex Bolts are recommended for center case mounting when device is used with hollow core wood, composite or light gauge hollow metal doors. See chart below for quantities and list prices.

Application	Sex Bolt 425 (Optional)	List Add
Hollow core wood, composite, or light gauge hollow metal doors - EO (exit only device)	8	96
Hollow core wood, composite, or light gauge hollow metal doors - Device x Trim	4	48

Device Series F-25-R
3' Devices are priced with standard trim and strike, 4' add \$19 list.
Cylinders are not included in the price.

FIRE EXIT HARDWARE
Rim Devices
 (Price includes 299F Strike)

	Trim/Control	US19* US26D	US26	US11* US15*
* F-25-R-EO		1232	1274	1407
* F-25-R-NL-OP (Supplied as NL less trim)		1232	1274	1407
Lever - Dane (handed and field reversible)				
* F-25-R-L	510L*	1604	1652	1785
* F-25-R-L-BE	510L-BE*	1604	1652	1785
* F-25-R-L-NL	510L-NL*	1529	1621	1754
* F-25-R-L-DT	510L-DT*	1529	1621	1754
VR Lever (handed and field reversible)				
* F-25-R-L	511L*	1656	1707	1840
Thumbpiece (non-handed)				
F-25-R-TP	512TP	1543	1639	1772
F-25-R-TP-BE	512TP-BE	1543	1639	1772
* F-25-R-NL	512-NL*	1481	1568	1701
Knob (non-handed)				
F-25-R-K	513K	1510	1600	1733
F-25-R-K-BE	513K-BE	1510	1600	1733
F-25-R-K-NL	513K-NL	1510	1600	1733
F-25-R-K-DT	513K-DT	1510	1600	1733
DT Pull (717 handed and field reversible, 512 non-handed)				
F-25-R-DT	717DT	1481	1523	1656
F-25-R-DT	512DT	1426	1568	1701

* These devices and 510L, 510L-BE, 510L-NL, 510L-DT, 511L, 512NL trims are available in US11, US15, and US19 finishes.
 Handing: F-25-R Device is non-handed. Trims are furnished RHR when handing is not specified.

Sex Bolts:
 Sex Bolts are supplied for center case mounting when device is used with wood, composite or non-reinforced hollow metal doors. See chart below for quantities.

Application	Sex Bolt 425 (Supplied)
Wood, composite or non-reinforced hollow metal doors - EO (exit only device)	8
Wood, composite or non-reinforced hollow metal doors - Device x Trim	4

25-V Device Series

3' Devices are priced with standard trim and strikes, 4' add \$19 list and 2' add \$123 list. Cylinders are not included in the price.

EXIT HARDWARE**Surface Vertical Rod Devices**

(Includes 3788 & 2130 Strikes)

	Trim/Control	US19* US26D	US26	US11* US15*
* 25-V-EO		1496	1559	1679
* 25-V-NL-OP (Supplied as NL less trim)		1496	1599	1679
Lever - Dane (handed and field reversible)				
* 25-V-L	510L*	1868	1937	2057
* 25-V-L-BE	510L-BE*	1868	1937	2057
* 25-V-L-NL	510L-NL*	1793	1906	2026
* 25-V-L-DT	510L-DT*	1793	1906	2026
VR Lever (handed and field reversible)				
* 25-V-L	511L*	1920	1992	2112
Thumbpiece (non-handed)				
25-V-TP	512TP	1807	1924	2044
25-V-TP-BE	512TP-BE	1807	1924	2044
* 25-V-NL	512-NL*	1745	1853	1973
Knob (non-handed)				
25-V-K	513K	1774	1885	2005
25-V-K-BE	513K-BE	1774	1885	2005
25-V-K-NL	513K-NL	1774	1885	2005
25-V-K-DT	513K-DT	1774	1885	2005
DT Pull (717 handed and field reversible, 512 non-handed)				
25-V-DT	717DT	1745	1808	1928
25-V-DT	512DT	1690	1853	1973

* These devices and 510L, 510L-BE, 510L-NL, 510L-DT, 511L, 512NL trims are available in US11, US15, and US19 finishes.

Handing: The 25-V Device is handed and field reversible. Trims are furnished RHR when handing is not specified.

Extension Rods: For door heights over 7'0" up to 8'0", 12" extension rods are furnished at no additional charge at the time of device order.

For door heights over 8'0" up to 10'0" extension rods are furnished at prices shown in parts section with the device at the time of order.

MUST specify door height on order line.

Sex Bolts:

Optional Sex Bolts are recommended for center case and latch mounting when device is used with hollow core wood, composite or light gauge hollow metal doors. See chart below for quantities and list prices.

Application	Latches Sex Bolt 2729 (Optional)	Device Sex Bolt 425 (Optional)	List Add
Hollow core wood, composite or light gauge hollow metal doors - EO (exit only device)	6	6	126.00
Hollow core wood, composite or light gauge hollow metal doors - Device x Trim	6	2	78.00
Hollow core wood, composite or light gauge hollow metal doors - EO (exit only device) LBR	3	6	99.00
Hollow core wood, composite or light gauge hollow metal doors - Device x Trim LBR	3	2	51.00

F-25-V Device Series

3' Devices are priced with standard trim and strikes, 4' add \$19 list and 2' add \$123 list. Cylinders are not included in the price.

FIRE EXIT HARDWARE
Surface Vertical Rod Devices
 (Includes 3788 & 2130 Strikes)

	Trim/Control	US19* US26D	US26	US11* US15*
* F-25-V-EO		1684	1747	1867
* F-25-V-NL-OP (Supplied as NL less trim)		1684	1747	1867
Lever - Dane (handed and field reversible)				
* F-25-V-L	510L*	2056	2125	2245
* F-25-V-L-BE	510L-BE*	2056	2125	2245
* F-25-V-L-NL	510L-NL*	1981	2094	2214
* F-25-V-L-DT	510L-DT*	1981	2094	2214
VR Lever (handed and field reversible)				
* F-25-V-L	511L*	2108	2180	2300
Thumbpiece (non-handed)				
F-25-V-TP	512TP	1995	2112	2232
F-25-V-TP-BE	512TP-BE	1995	2112	2232
* F-25-V-NL	512-NL*	1933	2041	2161
Knob (non-handed)				
F-25-V-K	513K	1962	2073	2193
F-25-V-K-BE	513K-BE	1962	2073	2193
F-25-V-K-NL	513K-NL	1962	2073	2193
F-25-V-K-DT	513K-DT	1962	2073	2193
DT Pull (717 handed and field reversible, 512 non-handed)				
F-25-V-DT	717DT	1933	1996	2116
F-25-V-DT	512DT	1878	2041	2161

* These devices and 510L, 510L-BE, 510L-NL, 510L-DT, 511L, 512NL trims are available in US11, US15, and US19 finishes.
Handing: The F-25-V Device is handed and field reversible. Trims are furnished RHR when handing is not specified.
Extension Rods: For door heights over 7'0" up to 8'0", 12" extension rods are furnished at no additional charge at the time of device order. For door heights over 8'0" up to 10'0" extension rods are furnished at prices shown in parts section with the device at the time of order. MUST specify door height on order line.

Sex Bolts:

Sex Bolts are supplied for center case mounting and latch mounting when device is used with wood, composite or non-reinforced hollow metal doors. See chart below for quantities.

Application	Latches Sex Bolt 2729 (Supplied)	Device Sex Bolt 425 (Supplied)
Wood, composite or non-reinforced hollow metal doors - EO (exit only device)	6	6
Wood, composite or non-reinforced hollow metal doors - Device x Trim	6	2
Wood, composite or non-reinforced hollow metal doors - EO (exit only device) LBR	3	6
Wood, composite or non-reinforced hollow metal doors - Device x Trim LBR	3	2

25 Device Options

Cylinder Dogging Not for use with Fire Exit Hardware

Prefix		List Add
CD	Cylinder Dogging available on all 25 series Panic Devices.	60
LD	Less Dogging available on all 25 series Panic Devices.	27

Less Bottom Rod

Suffix		List Add
LBR	Less Bottom Rod available with UL Fire Label at no additional charge on F-25-V and F-25-C devices. Fire rated LBR devices must be ordered in pairs of Vertical Rod Devices. For Fire Rated Devices specify one device LBR and second device LBR-AFL. Second device provided with a Fire Pin.	N/C

Accessible Device

Suffix		List Add
AX	Accessible device compliant with the California Building Code (Section 11B-309.4) requirement for 5 lb. maximum operational force. Available on 3' and 4' AX-25-R, AX-F-25-R, AX-25-V, AX-F-25-V, AX-25-V-LBR, AX-F-25-V-LBR/LBR-AFL, AX-25-C, AX-F-25-C, AX-25-C-LBR, AX-F-25-C-LBR/LBR-AFL. Trim functions available EO, DT, NL, L, L-BE, L-NL, L-DT, NL-OP, and C. Other device and trim options compatible with AX25 devices: EL, RX, DM, LM, CON, EA, FSA/FSE, CD, LD.	23

Hurricane Device Meets all FBC Hurricane Listings. Consult factory for specific Applications.

Prefix		List Add
HH	Hurricane option available on 25-R, F-25-R, 25-V, F-25-V. Prefix device "HH". Note: HH25-V and HH-F-25-V, will be supplied with twelve sexbolts. Add \$126.00 LIST	27
	Standard Devices 25-C, F-25-C, 25-M, F-25-M meet all FBC Hurricane listing requirements. Consult factory for specific applications. Prefix "HH" is not required on these devices.	N/C

Electric Latch Retraction

Prefix		List Add
EL	Electric Latch Retraction - Available on all 25 series Panic and Fire Devices. Electric Latch cannot be used in combination with CD, EA or KOR options.	513

REFERENCE NOTE: PS914 is required for EL operation. See Power Supply section for more detail.

Device Monitoring

Prefix		List Add
RX	Touch Bar Request to Exit Switch available on all 25 series devices. RX dogging monitoring switch can be used in combination with a DM or LM switch.	195
DM	Latch Bolt Monitor Switch (provide signal when latch bolt is fully extended) available on all 25 series devices. DM device monitoring switch can be used in combination with a RX switch, but is not available in combination with a LM switch.	204
LM	Latch Bolt Monitoring Switch (provide signal when latch bolt is fully retracted) available on all 25 series devices. LM device monitoring switch can be used in combination with a RX switch, but is not available in combination with a DM switch.	195
KOR	Key Override - Override device monitoring on a door by use of a keyed cylinder. KOR must be used in combination with a device monitoring switch.	54

Allegion Connect

Suffix		List Add
CON	Cross-category solution using common interconnect components for electrified options. Available with EL, RX, DM, LM, EA, RX-DM, RX-LM, EL-RX, EL-DM, EL-LM options. Also available as an option on FSA and FSE options for the Falcon 25 series trim.	N/C

NOTE: For wire harness options refer to Power Supply and Electronic Component Section.

Exit Alarm

Prefix		List Add
EA	Exit Alarm available on 25-R and 25-V Panic and Fire Devices. Price includes switch - "RX" is standard, "LM" is optional at no charge. To order "Less Switch", Deduct \$195 list . For vertical rod tampering monitoring on Surface Vertical Devices, specify device with DM (Latch Bolt Monitor Switch). Add \$204 list . 9 volt battery included.	483

Electric Lock or Unlock of Trims

Prefix		List Add
FSA	Electric Lock/Unlock Trim, Fail Safe (unlocks when power is interrupted).	285
FSE	Electric Lock/Unlock Trim, Fail Secure (locks when power is interrupted).	285

REFERENCE NOTES:

FSA/FSE available on all 25 series devices. Available with TP, K, or L functions only. Can be used in combination with EL, EA, or any device monitoring switch. Power supply PS902 is the recommended power supply for use with FSA/FSE trim. If paired with an EL device, PS914 is required. See the power supply section for more information.

25 Series Trims

Cylinders are not included in price.

Lever Trim

Model No.	Lever Style	Device Type	Description	US19* US26D	US11* US15* US26 US32
510L	Dane	R,V,M,C	Lever, Key Locks or Unlocks	372	378
510L-NL	Dane	R,V,M,C	Lever, Night Latch	297	347
510L-DT	Dane	R,V,M,C	Lever, Dummy Trim	297	347
510L-BE	Dane	R,V,M,C	Lever, Blank Escutcheon	372	378

* US11, US15, US19 are available on the lever trim type listed above except Sutro.

510 series trim are handed and field reversible. Trims are furnished RHR when handing is not specified.

The Dane Lever is furnished standard. Optional lever designs Broadway, Boardwalk, Danish, Latitude, Longitude, Sutro, Quantum and Avalon are available at no additional charge.

Electric Lock or Unlock option is available on 510L function only.

Suffix FSA for Fail Safe operation, or **FSE** for Fail Secure operation, **add \$285 List.**

Knurling on Dane lever, **add \$61 List.** Contact factory for lead times.

Vandal Resistant Trim

Model No.	Lever Style	Device Type	Description	US32D US19* US26D	US3 US11* US15* US26 US32
511L*	Dane	R,V,M,C	Lever, Key Locks or Unlocks	424	433

* US11, US15, US19 are available on the lever trim type listed above except Sutro.

511 series trim are handed and field reversible. Trims are furnished RHR when handing is not specified.

The Dane Lever is furnished standard. Optional lever designs Broadway, Boardwalk, Danish, Latitude, Longitude, Sutro, Quantum and Avalon are available at no additional charge.

Electric Lock or Unlock option is available on 511L.

Suffix FSA for Fail Safe operation, or **FSE** for Fail Secure operation, **add \$285 List.**

Night Latch and Thumbpiece Trim

Model No.	Device Type	Description	US32D US19* US26D	US3 US11* US15* US26 US32
512NL*	R,V,M,C	Night Latch	249	294
512TP	R,V,M,C	Thumbpiece, Key Locks or Unlocks	311	365
512TP-BE	R,V,M,C	Thumbpiece, Blank Escutcheon	311	365

* Available in US11, US15, US19 on all Falcon Exit levers except for Sutro.

Electric Lock or Unlock option is available on 512TP function only.

Suffix FSA for Fail Safe operation, or **FSE** for Fail Secure operation, **add \$285 List.**

Knob Trim

Model No.	Device Type	Description	US32D US26D	US3 US26 US32
513K	R,V,M,C	Knob, Key Locks or Unlocks	278	326
513K-NL	R,V,M,C	Knob, Night Latch	278	326
513K-DT	R,V,M,C	Knob, Dummy Trim	278	326
513K-BE	R,V,M,C	Knob, Blank Escutcheon	278	326

Electric Lock or Unlock option is available on 513K function only.

Suffix FSA for Fail Safe operation, or **FSE** for Fail Secure operation, **add \$285 List.**

Pull Trim

Model No.	Device Type	Description	US32D US26D	US3 US26 US32
512DT	R,V,M,C	Dummy Trim	194	294

Delta Trim

Model No.	Device Type	Description	SP313 US15 US32D	US19* US26D US3, US11* US26 US32
717DT	R,V,M,C	Dummy Trim	213	249
718C*	C	Night Latch Less Pull	174	191

* Available in US11 and US19.

717 and 718 series trim are handed and field reversible. Trims are furnished RHR when handing is not specified.

19-R Device Series

3' Devices are priced with standard trim and strikes, 4' add \$19 list.

Cylinders are not included in price unless noted.

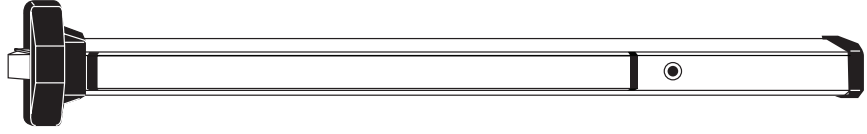
**EXIT HARDWARE****Rim Devices** (Includes F570 Strike)

		SP28 SP313	US32D
Trim/Control			
19-R-EO		285	502
Trident Trim (must specify handing)			
19-R-DT	920DT	323	540
19-R-NL	920NL	352	569
Centron Trim (non-handed)			
19-R-EO	930EO	319	536
19-R-DT	930DT	323	540
19-R-NL	930NL	338	555
19-R-C	930C	332	549
19-R-DT	917DT	315	532
Control Trim (non-handed)			
19-R-DT	918DT	396	705
19-R-NL	918NL	396	705
Knob Control (handed and field reversible)			
19-R-K	911K	396	705
19-R-K-BE	911K-BE	396	705
19-R-K-NL	911K-NL	396	705
Dane Lever Control (handed and field reversible)			
19-R-L	912L	439	739
19-R-L-BE	912L-BE	439	739
19-R-L-NL	912L-NL	439	739
19-R-L-DT	912L-DT	439	739
Key in Lever (handed and field reversible)			
19-R-KIL	914-KIL-KD W/CYL	470	687
19-R-KIL-NL	914-KIL-NL-KD W/CYL	470	687
19-R-KIL-BE	914-KIL-BE	470	687
19-R-KIL-IC	914-KIL-IC W/CYL	513	730

REFERENCE NOTE:

930 series trim is available in SP313 and US32D finish only. 19 series devices order in SP28 paired with 930 trim are supplied with US32D finish trim.

Sex Bolts:

Three 4122 Sex Bolts are supplied standard no charge, one for hinge side mounting and two for center case mounting.

F-19-R Device Series

3' Devices are priced with standard trim and strike, 4' add \$19 list. Cylinders are not included in the price unless noted.

FIRE EXIT HARDWARE

Rim Devices (Includes F570 Strike)

		SP28 SP313	US32D
Trim/Control			
F-19-R-EO		356	586
Trident Trim (must specify handing)			
F-19-R-DT	920DT	394	624
F-19-R-NL	920NL	423	653
Centron Trim (non-handed)			
F-19-R-EO	930EO	390	620
F-19-R-DT	930DT	394	624
F-19-R-NL	930NL	409	639
F-19-R-C	930C	403	633
F-19-R-DT	917DT	386	616
Control Trim (non-handed)			
F-19-R-DT	918DT	467	789
F-19-R-NL	918NL	467	789
Knob Control (handed and field reversible)			
F-19-R-K	911K	467	789
F-19-R-K-BE	911K-BE	467	789
F-19-R-K-NL	911K-NL	467	789
Dane Lever Control (handed and field reversible)			
F-19-R-L	912L	510	823
F-19-R-L-BE	912L-BE	510	823
F-19-R-L-NL	912L-NL	510	823
F-19-R-L-DT	912L-DT	510	823
Key in Lever (handed and field reversible)			
F-19-R-KIL	914-KIL-KD W/CYL	541	771
F-19-R-KIL-NL	914-KIL-NL-KD W/CYL	541	771
F-19-R-KIL-BE	914-KIL-BE	541	771
F-19-R-KIL-IC	914-KIL-IC W/CYL	584	814

REFERENCE NOTE:

930 series trim is available in SP313 and US32D finish only. 19 series devices order in SP28 paired with 930 trim are supplied with US32D finish trim.

Sex Bolts:

Three 4122 Sex Bolts are supplied standard, one for hinge side mounting and two for center case mounting. Two 2729 Sex bolts are supplied for additional center case mounting when device is used with wood, composite or non-reinforced hollow metal doors.

Application	Sex Bolt 2729 (Supplied)
Wood, composite or non-reinforced hollow metal doors	2

19-V Device Series**3' Devices are priced with standard trim and strikes, 4' add \$19 list.****Cylinders are not included in the price unless noted.****EXIT HARDWARE****Surface Vertical Rod Devices**

(Includes 3788 and 2130 Strikes)

		SP28 SP313	US32D
Trim/Control			
19-V-EO		440	837
Trident Trim (must specify handing)			
19-V-DT	920DT	478	875
19-V-NL	920NL	507	904
Centron Trim (non-handed)			
19-V-EO	930EO	474	871
19-V-DT	930DT	478	875
19-V-NL	930NL	493	890
19-V-C	930C	487	884
19-V-DT	917DT	470	867
Control Trim (non-handed)			
19-V-DT	918DT	551	1040
19-V-NL	918NL	551	1040
Knob Control (handed and field reversible)			
19-V-K	911K	551	1040
19-V-K-BE	911K-BE	551	1040
19-V-K-NL	911K-NL	551	1040
Dane Lever Control (handed and field reversible)			
19-V-L	912L	594	1074
19-V-L-BE	912L-BE	594	1074
19-V-L-NL	912L-NL	594	1074
19-V-L-DT	912L-DT	594	1074
Key in Lever (handed and field reversible)			
19-V-KIL	914-KIL-KD W/CYL	625	1022
19-V-KIL-NL	914-KIL-NL-KD W/CYL	625	1022
19-V-KIL-BE	914-KIL-BE	625	1022
19-V-KIL-IC	914-KIL-IC W/CYL	668	1065

REFERENCE NOTES:**Handing:** 19-V devices are handed and field reversible. Devices and Trims are furnished RHR when handing is not specified.**Extension Rods:** For door heights over 7'0" up to 8'0", 12" extension rods are furnished at no additional charge at the time of device order.

For door heights over 8'0" up to 10'0" extension rods are furnished at prices shown in parts section with the device at the time of order.

MUST specify door height on order line.

930 series trim is available in SP313 and US32D finish only. 19 series devices order in SP28 paired with 930 trim are supplied with US32D finish trim.**Sex Bolts:**

Three 4122 Sex Bolts are supplied standard no charge, one for hinge side mounting and two for center case mounting.

Six 2729 Sex Bolts are recommended for latch mounting when device is used with hollow core, composite or light gauge hollow metal doors. See chart below for quantities and list prices.

Application	Sex Bolt 2729 (Optional)	List Add
Hollow core, composite or light gauge hollow metal doors	6	54

F-19-V Device Series

3' Devices are priced with standard trim and strikes, 4' add \$19 list.

Cylinders are not included in the price unless noted.

FIRE EXIT HARDWARE

Surface Vertical Rod Devices

(Includes 3788 and 2130 Strikes)

	Trim/Control	SP28 SP313	US32D
F-19-V-EO		554	942
Trident Trim (must specify handing)			
F-19-V-DT	92ODT	592	980
F-19-V-NL	92ONL	621	1009
Centron Trim (non-handed)			
F-19-V-EO	930EO	588	976
F-19-V-DT	930DT	592	980
F-19-V-NL	930NL	607	995
F-19-V-C	930C	601	989
F-19-V-DT	917DT	584	972
Control Trim (non-handed)			
F-19-V-DT	918DT	665	1145
F-19-V-NL	918NL	665	1145
Knob Control (handed and field reversible)			
F-19-V-K	911K	665	1145
F-19-V-K-BE	911K-BE	665	1145
F-19-V-K-NL	911K-NL	665	1145
Dane Lever Control (handed and field reversible)			
F-19-V-L	912L	708	1179
F-19-V-L-BE	912L-BE	708	1179
F-19-V-L-NL	912L-NL	708	1179
F-19-V-L-DT	912L-DT	708	1179
Key in Lever (handed and field reversible)			
F-19-V-KIL	914-KIL-KD W/CYL	739	1127
F-19-V-KIL-NL	914-KIL-NL-KD W/CYL	739	1127
F-19-V-KIL-BE	914-KIL-BE	739	1127
F-19-V-KIL-IC	914-KIL-IC W/CYL	782	1170

REFERENCE NOTES:

Handing: F-19-V devices are handed and field reversible. Devices and Trims are furnished RHR when handing is not specified.

Extension Rods: For door heights over 7'0" up to 8'0", 12" extension rods are furnished at no additional charge at the time of device order.

For door heights over 8'0" up to 10'0" extension rods are furnished at prices shown in parts section with the device at the time of order.

MUST specify door height on order line.

930 series trim is available in SP313 and US32D finish only. 19 series devices order in SP28 paired with 930 trim are supplied with US32D finish trim.

Sex Bolts:

Three 4122 Sex Bolts are supplied standard no charge, one for hinge side mounting and two for center case mounting.

Six 2729 are supplied for additional latch case mounting when device is used with wood, composite or non-reinforced hollow metal doors.

Application	Sex Bolt 2729 (Supplied)
Wood, composite or non-reinforced hollow metal doors	6

19 Device Options

Cylinder Dogging

Not for use with Fire Exit Hardware

Prefix		List Add
CD	Cylinder Dogging available on all 19 series Panic Devices.	60
LD	Less Dogging available on all 19 series Panic Devices	27

Less Bottom Rod

Suffix		List Add
LBR	Less Bottom Rod available with UL Fire Label at no additional charge on F-19-V devices. Fire rated LBR devices must be ordered in pairs of Vertical Rod Devices. For Fire Rated Devices specify one device LBR and second device LBR-AFL. Second device provided with a Fire Pin.	N/C

* The 19-Series Exit Alarm option has been eliminated. Consult Customer Care for availability and warranty claims.

Accessible Device

Suffix		List Add
AX	Accessible device compliant with the California Building Code (Section 11B-309.4) requirement for 5 lb. maximum operational force. Available on 3' and 4' AX-19-R, AX-F-19-R, AX-19-V, AX-F-19-V, AX-19-V-LBR, AX-F-19-V-LBR/LBR-AFL. Trim functions available EO, DT, NL, L, L-BE, L-NL, L-DT, C, KIL, KIL-BE, KIL-NL, and KIL-IC.	23

1690 Concealed Vertical Rod Pushpad Exit Devices

Devices are priced for 30", 36" x 7',

Aluminum or Hollow Metal Doors.

Hex Bottom Latch furnished standard.

(Price includes PB48 Strike)

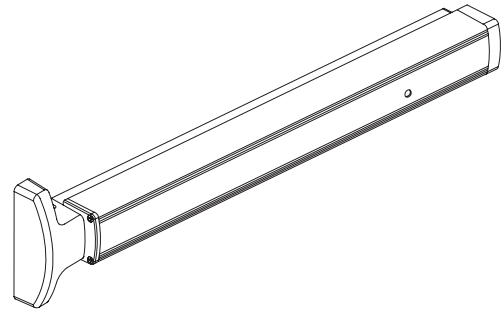

Model No.	US26	US26D	Standard Trim
1690EO	594	573	-
1691DT	961	938	9970 Pull
1692NL-OP/HB-OP	680	657	169CA w/Rim Cylinder
1694NL-P/HB-P	1047	1024	9970 Pull 169CA w/Rim Cylinder

REFERENCE NOTES:

Devices are supplied 36" x 7' standard, if not specified.

Rim cylinder supplied standard with NL and HB options is C keyway.

Extra Length

	List Add
42"	19.00
48"	27.00

Optional Latches

Suffix		List Add
RL	Rod Bottom Latch	27.00
PL	Pullman Bottom Latch	27.00
ES	Top Latch for use with Electric Strikes Device Furnished LBR (Less Bottom Rod and Less Strike) deduct \$23 List	31.00
Less Rods	For retrofit of 1990 crossbar device, deduct \$47 List	

Door Heights over 7'

	List Add
Up to 8'	62.00
Up to 9'	80.00
Up to 10'	91.00

Device Options

		List Add
RX Switch	Base Exit Device unit modified Request to Exit Switch monitoring pushpad. Prefix device "RX".	203.00
Electric Latch Retraction	Base Exit Device unit modified with Electric Latch Retraction. Prefix device "EL". The EL option is not field replaceable on this model.	546.00

**(One PS914 x 900-2RS is the minimum requirement to power one or two EL devices.
See Power Supply Section for requirements and options.)**

Electric Dogging	Base Exit Device unit modified with Electric Dogging Prefix device "ED".	546.00
HH	Hurricane device. Available up to 8' device only. Prefix device "HH". HH is for a Hurricane device for all door manufactures other than YKK.	109.00
HHYKK	Hurricane device. Available up to 8' device only. Prefix device "HHYKK". HHYKK is for a Hurricane device for door manufacture YKK.	109.00

REFERENCE NOTES:

For EL1690 Door widths other than the standard size (30", 36", 42" or 48"), please specify exact door width. For non-standard widths, the price of the next widest standard size will apply.
HH (Hurricane) 1690 devices are hurricane rated by specific door manufacturers. Consult your device manufacturer to assure the HH1690 is hurricane rated with their door solution.

1790 Series Rim Type Pushpad Exit Devices

Devices are priced for 30" and 36",
Aluminum or Hollow Metal Doors.

(Price includes TD35 Strike)

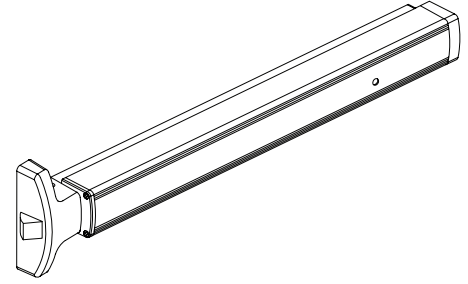

Model No.	US26	US26D	Standard Trim
1790EO	552	532	-
1791DT	919	899	9970 Pull
1792NL-OP/HB-OP	638	618	179CA w/Rim Cylinder
1794NL-P/HB-P	1005	985	9970 Pull 179CA w/Rim Cylinder

REFERENCE NOTES:

Devices are supplied 36" x 7" standard, if not specified.

Rim cylinder supplied standard with NL and HB options is C keyway.

Extra Length	List Add
42"	19.00
48"	27.00

Device Options	List Add
RX Switch Base Exit Device unit modified Request to Exit Switch monitoring pushpad. Prefix device "RX".	203.00
Electric Latch Retraction Base Exit Device unit modified with Electric Latch Retraction. Prefix device "EL". The EL option is not field replaceable on this model.	546.00
(One PS914 x 900-2RS is the minimum requirement to power one or two EL devices. See Power Supply Section for requirements and options.)	
Electric Dogging Base Exit Device unit modified with Electric Dogging Prefix device "ED".	546.00

REFERENCE NOTES:

For EL1790 Door widths other than the standard size (30", 36", 42" or 48"), please specify exact door width.

For non-standard widths, the price of the next widest standard size will apply.

Lever Control

		P28 P13 P35	US15
179L	Lever Control	317	354
179L-BE	Lever Control, Blank Escutcheon	317	354
179L-NL	Lever Control, Night Latch	317	354

REFERENCE NOTES:

Lever Controls are Handed. Specify handing RHR or LHR.

179L Trims are field retrofittable with all 1790 Series Devices.

For initial installation requiring lever trim, the 1790EO is the suggested device to order with the 179L trims.

179L and L-NL require a 1 1/8" mortise cylinder with straight cam, sold separately.

1990 Concealed Vertical Rod Crossbar Exit Devices

Devices are priced for 3'8" x 7',
 Aluminum or Hollow Metal Doors.
 Hex Bottom Latch furnished standard.
 (Price includes PB48 Strike)

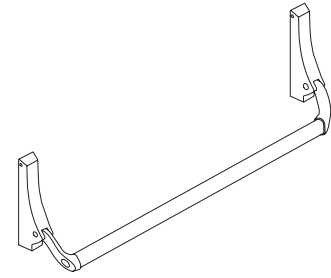

Model No.	US26D	Standard Trim
1990EO	1196	-
1991DT	1563	9970 Pull
1992NL-OP/HB-OP	1282	Rim Cylinder only
1993NL/HB	1649	9970 w/Rim Cylinder

REFERENCE NOTES:

Rim cylinder supplied standard with NL and HB options is C keyway.

Optional Latches

Suffix		List Add
RL	Rod Bottom Latch	27.00
PL	Pullman Bottom Latch	27.00
ES	Top Latch for use with Electric Strikes Device Furnished LBR (Less Bottom Rod and Less Strike) deduct \$23.00 List	31.00

Door Heights over 7'

	List Add
Up to 8'	62.00
Up to 9'	80.00
Up to 10'	91.00

Crossbar

	List Add
Crossbar furnished 41" standard - Easily Cut for Job Fitting	
Extra Length Crossbar - 48" (Fits Door Width up to 51") - P28, P13, P35 finishes	20.00
Extra Length Crossbar - 48" (Fits Door Width up to 51") - Architectural finishes	29.00
Less Crossbar, deduct \$113 List	

REFERENCE NOTES:

Specify if Door Material other than Aluminum. Not recommended for use on wood doors.

2090 Rim Type Crossbar Exit Devices

Devices are priced for 3'8", Aluminum or Hollow Metal Doors.

(Price includes SD36 Strike)

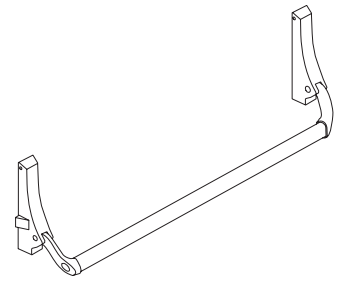

Model No.	US26D	Standard Trim
2090EO	1110	-
2091DT	1477	9970 Pull
2092NL-OP/HB-OP	1196	Rim Cylinder only
2093NL/HB	1562	9970 w/Rim Cylinder

REFERENCE NOTES:

Rim cylinder supplied standard with NL and HB options is C keyway.

Crossbar

	List Add
Crossbar furnished 41" standard - Easily Cut for Job Fitting	
Extra Length Crossbar - 48" (Fits Door Width up to 51") - P28, P13, P35 finishes	20.00
Extra Length Crossbar - 48" (Fits Door Width up to 51") - Architectural finishes	29.00
Less Crossbar, deduct \$113 List	

REFERENCE NOTES:

Specify if Door Material other than Aluminum. Specify Handing RHR or LHR. Not Reversible.

Surface Door Closers

1250 Series Surface Door Closers

- Light duty cast aluminum door closer
- Adjustable sizes 1-5
- ANSI/BHMA 156.4, Grade 1 certified
- Closers without Hold-Open arms are UL 10C fire rated

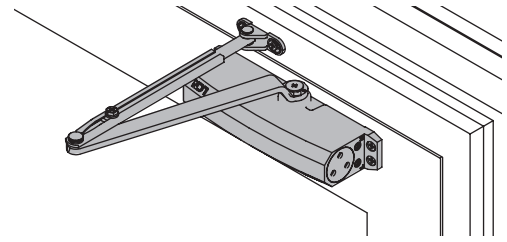

Series	Arms	Finish	Handing	Cylinder Assembly	Cover	Price Ea.
1250	⊗	Rw/PA	-	Std	None	\$205.00
1250	⊗	Rw/PA	-	Std	Slim	220.00
1250	⊗	Hw/PA	-	Std	None	235.00
1250	⊗	Hw/PA	-	Std	Slim	250.00
1250	⊗	Rw/PA	-	Std	None	205.00
1250	⊗	Rw/PA	-	Std	Slim	220.00
1250	⊗	Hw/PA	-	Std	None	235.00
1250	⊗	Hw/PA	-	Std	Slim	250.00

1260 Series Surface Door Closers

- Light-medium duty cast iron door closer
- Adjustable sizes 1-5
- ANSI/BHMA 156.4, Grade 1 certified
- Closers without Hold-Open arms are UL 10C fire rated

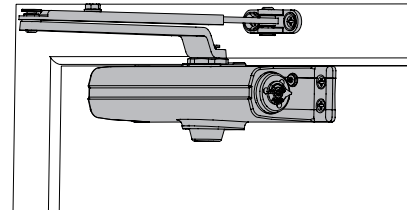

Series	Arms	Finish	Handing	Cylinder Assembly	Cover	Price Ea.
1261	⊗	Rw/PA	-	Std	None	\$271.00
1261	⊗	Hw/PA	-	Std	None	303.00
1261	⊗	Rw/PA	-	Std	None	\$271.00
1261	⊗	Hw/PA	-	Std	None	303.00

1450 Series Surface Door Closers

- Medium duty cast aluminum door closer
- Adjustable sizes 1-6
- ANSI/BHMA 156.4, Grade 1 certified
- Closers without Hold-Open arms are UL 10C fire rated

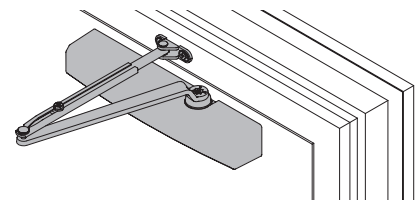

Series	Arms	Finish	Handing	Cylinder Assembly	Cover	Price Ea.
1450	⊗	Rw/PA	-	Std	Slim	\$275.00
1450	⊗	Rw/PA	-	Std	Full	285.00
1450	⊗	Hw/PA	-	Std	Slim	305.00
1450	⊗	Hw/PA	-	Std	Full	315.00
1450	⊗	Rw/PA	-	Std	Slim	275.00
1450	⊗	Rw/PA	-	Std	Full	285.00
1450	⊗	Hw/PA	-	Std	Slim	305.00
1450	⊗	Hw/PA	-	Std	Full	315.00

Notes: **AL** = Aluminum finish (689); **DKBRZ** = Dark bronze finish (695); **Rw/PA** = Regular arm with parallel arm bracket
Hw/PA = Hold open arm with parallel arm bracket (Please note hold open arm configurations are not UL listed.)

Surface Door Closers (continued)

1460 Series Surface Door Closers

- Medium duty cast iron door closer
- Adjustable sizes 1-6
- ANSI/BHMA 156.4, Grade 1 certified
- Closers without Hold-Open arms are UL 10C fire rated

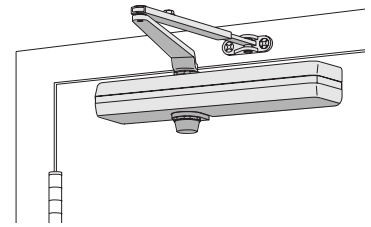

Series		Arms	Finish	Handing	Cylinder Assembly	Cover	Price Ea.
1461	☺	Rw/PA	AL	-	Std	Slim	\$346.00
1461	☹	Rw/PA	AL	-	Std	Full	356.00
1461	☺	Hw/PA	AL	-	Std	Slim	378.00
1461	☹	Hw/PA	AL	-	Std	Full	388.00
1461	☺	Rw/PA	DKBRZ	-	Std	Slim	346.00
1461	☹	Rw/PA	DKBRZ	-	Std	Full	356.00
1461	☺	Hw/PA	DKBRZ	-	Std	Slim	378.00
1461	☹	Hw/PA	DKBRZ	-	Std	Full	388.00

4040XP Series Surface Door Closers

- Heavy duty cast iron door closer
- Adjustable sizes 1-6
- ANSI/BHMA 156.4, Grade 1 certified
- Closers without Hold-Open arms are UL 10C fire rated

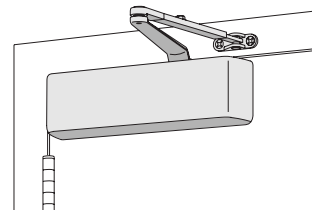

Series		Arms	Finish	Handing	Cylinder Assembly	Cover	Price Ea.
4040XP	☺	Rw/PA	AL	-	Std	Full	\$497.00
4040XP	☹	Hw/PA	AL	-	Std	Full	556.00
4040XP	☺	EDA	AL	-	Std	Full	540.00
4040XP	☹	Cush	AL	-	Std	Full	572.00
4040XP	☺	SCUSH	AL	-	Std	Full	625.00
4040XP	☹	Rw/PA	DKBRZ	-	Std	Full	497.00
4040XP	☺	Hw/PA	DKBRZ	-	Std	Full	556.00
4040XP	☹	EDA	DKBRZ	-	Std	Full	540.00
4040XP	☺	Cush	DKBRZ	-	Std	Full	572.00
4040XP	☹	SCUSH	DKBRZ	-	Std	Full	625.00

4050 Series Surface Door Closers

- Heavy duty cast aluminum door closer
- Adjustable sizes 1-6
- ANSI/BHMA 156.4, Grade 1 certified
- Closers without Hold-Open arms are UL 10C fire rated

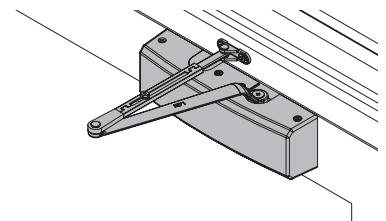

Series		Arms	Finish	Handing	Cylinder Assembly	Cover	Price Ea.
4050	☺	Rw/PA	AL	-	Std	Full	\$435.00
4050	☹	Hw/PA	AL	-	Std	Full	475.00
4050	☺	EDA	AL	-	Std	Full	465.00
4050	☹	Cush	AL	-	Std	Full	495.00
4050	☺	SCUSH	AL	-	Std	Full	555.00
4050	☹	Rw/PA	DKBRZ	-	Std	Full	435.00
4050	☺	Hw/PA	DKBRZ	-	Std	Full	475.00
4050	☹	EDA	DKBRZ	-	Std	Full	465.00
4050	☺	Cush	DKBRZ	-	Std	Full	495.00
4050	☹	SCUSH	DKBRZ	-	Std	Full	555.00

Notes: **ALUM** = Aluminum painted finish (689); **DKBRZ** = Dark bronze finish (695); **Rw/PA** = Regular arm with parallel arm bracket
Hw/PA = Hold open arm with parallel arm bracket (Please note hold open arm configurations are not UL listed.)
EDA = Extra Duty Parallel Arm; **CUSH** = Cush-n-stop; **SCUSH** = Spring cush-n-stop

Parts and Components

Series	Number	Product Description	Finish	List Price
1250	18	Drop Plate	ALUM	\$42.00
1250	18PA	Drop Plate - PA	ALUM	42.00
1250	18	Drop Plate	DKBRZ	42.00
1250	18PA	Drop Plate - PA	DKBRZ	42.00
1260	18	Drop Plate	ALUM	42.00
1260	18PA	Drop Plate - PA	ALUM	42.00
1260	18	Drop Plate	DKBRZ	42.00
1260	18PA	Drop Plate - PA	DKBRZ	42.00
1450	18	Drop Plate	ALUM	54.00
1450	18PA	Drop Plate - PA	ALUM	54.00
1450	18FC	Drop Plate (for Full Cover)	ALUM	54.00
1450	18PAFC	Drop Plate - PA (for Full Cover)	ALUM	54.00
1450	18	Drop Plate	DKBRZ	54.00
1450	18PA	Drop Plate - PA	DKBRZ	54.00
1450	18FC	Drop Plate (for Full Cover)	DKBRZ	54.00
1450	18PAFC	Drop Plate - PA (for Full Cover)	DKBRZ	54.00
1460	18	Drop Plate	ALUM	58.00
1460	18PA	Drop Plate - PA	ALUM	58.00
1460	18FC	Drop Plate (for Full Cover)	ALUM	58.00
1460	18PAFC	Drop Plate - PA (for Full Cover)	ALUM	58.00
1460	18	Drop Plate	DKBRZ	58.00
1460	18PA	Drop Plate - PA	DKBRZ	58.00
1460	18FC	Drop Plate (for Full Cover)	DKBRZ	58.00
1460	18PAFC	Drop Plate - PA (for Full Cover)	DKBRZ	58.00
4050	18	Drop Plate	ALUM	58.00
4050	18PA	Drop Plate PA	ALUM	58.00
4050	18	Drop Plate	DKBRZ	58.00
4050	18PA	Drop Plate PA	DKBRZ	58.00

Notes: **AL** = Aluminum finish (689); **DKBRZ** = Dark bronze finish (695)

Automatic Operators

4600 Series Auto Equalizer

- Heavy duty electro hydraulic automatic operator
- Used when door is operated manually most of the time with occasional automatic opening
- ANSI/BHMA 156.19, UL 10C, UL 325

Series	Mounting	Arms	Finish	Handing	Cylinder Assembly	Cover	List Price
4630		Track	AL	-	Std	Metal	\$5,516.00
4630		Track	DKBRZ	-	Std	Metal	5,516.00
4642		Reg	AL	-	Std	Metal	5,422.00
4642		Reg	DKBRZ	-	Std	Metal	5,422.00

9100 Series Benchmark

- Medium duty electromechanical automatic operator
- Used when door is operated electronically most of the time
- ANSI/BHMA 156.19, UL 325

Series	Mounting	Arms	Finish	Handing	Cylinder Assembly	Cover	List Price
9130		Track	AL	-	Std	Metal	\$3,702.00
9130		Track	DKBRZ	-	Std	Metal	3,702.00
9140		Std	AL	-	Std	Metal	3,609.00
9140		Std	DKBRZ	-	Std	Metal	3,609.00

9500 Series Senior Swing

- Heavy duty electromechanical automatic operator
- Used when door is operated electronically most of the time
- ANSI/BHMA 156.19, UL 325, UL 10C

Series	Mounting	Arms	Finish	Handing	Cylinder Assembly	Cover	List Price
9530		Track	AL	RH	Std	Metal	\$4,723.00
9530		Track	AL	LH	Std	Metal	4,723.00
9530		Track	DKBRZ	RH	Std	Metal	4,723.00
9530		Track	DKBRZ	LH	Std	Metal	4,723.00
9540		Std	AL	RH	Std	Metal	4,600.00
9540		Std	AL	LH	Std	Metal	4,600.00
9540		Std	DKBRZ	RH	Std	Metal	4,600.00
9540		Std	DKBRZ	LH	Std	Metal	4,600.00

SC60A Series Closers

SC60A Series

Light-Medium Duty

Model	Arm Type	Shipping Weight	AL (689) DKB (695) MTBK (622) ¹
SC61A	RwPA	7	155
SC61A	HwPA	7	177
SC61A	HDPA ¹	7	177
SC61A	DS	9	195
SC61A	DSHO ¹	9	217
SC61A	SS ¹	9	258
SC61A	SSHO ¹	9	275

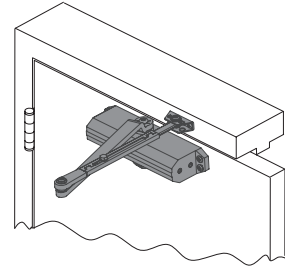

60A Series

REFERENCE NOTES:

- 1) SC61A HD, DS/HO, SS, and SS/HO are not available in matte black.
- 2) SC61A ships standard as LESS cover.
- 3) SC61A is fully adjustable 1-5

Closer Options

Suffix	Description	List Adder
SLIM	SLIM Cover	15

Closer Parts and Accessories

Model	Description	Shipping Weight	List
SC61A-3071	Standard Cylinder	9	96
SC60A-72	Slim Cover	1	15
SC60A-3077/PA	Regular Arm w/ PA Bracket	3	60
SC60A-3049/PA	Hold Open Arm w/ PA Bracket	3	81
SC60A-3077HD	Heavy Duty Parallel Arm ¹	3	81
SC60A-3077DS	Dead Stop Parallel Arm	5	99
SC60A-3049DS	Hold Open Dead Stop Parallel Arm ¹	5	121
SC60A-3077SS	Spring N Stop Arm ¹	5	162
SC60A-3049SS	Hold Open Spring N Stop Arm ¹	5	179
SC60A-18	Mounting Plate - Top Jamb	2	31
SC60A-18PA	Mounting Plate - Push Side	2	31
SC60A-30	Cush Shoe Support	1	20
SC60A-61	Blade Stop Spacer	1	22
SSC60A-62A	Offset Auxiliary Shoe	1	26

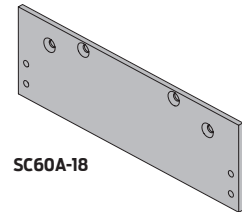

SC60A-18

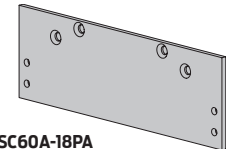

SC60A-18PA

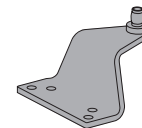

SC60A-62A

REFERENCE NOTES:

- 1) SC61A, HD, DS/HO, SS, and SS/HO arms are not available in matte black.
- 2) Matte Black and Dark Bronze Closers share the same screw finish.

SC70A Series Closers

SC70A Series

Heavy Duty

Model	Arm Type	Shipping Weight	AL (689) DKB (695) MTBK (622) ¹
SC71A	RwPA	10	306
SC71A	HwPA	10	327
SC71A	HDPA	11	327
SC71A	FAI	11	343
SC71A	FAHO ¹	11	365
SC71A	DS	11	345
SC71A	DSHO ¹	12	367
SC71A	SS ¹	12	408
SC71A	SSHO ¹	12	425

REFERENCE NOTES:

- 1) SC71 FA, FA/HO, DS/HO, SS, and SS/HO are not available in matte black.
- 2) SC71 ships standard with a FULL Cover.
- 3) SC71 is fully adjustable 1-6

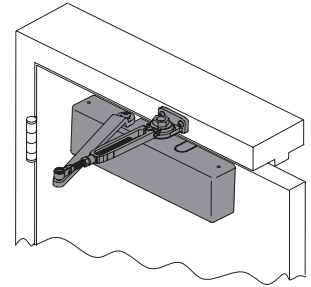

SC70A Series

Closer Parts and Accessories

Model	Description	Shipping Weight	List
SC71A-3071	Standard Cylinder	12	230
SC71A-3071DEL	Delay Cylinder ¹	12	262
SC70A-72	FULL Cover	1	15
SC70A-3077/PA	Regular Arm w/ PA Bracket	3	60
SC70A-3049/PA	Hold Open Arm w/ PA Bracket	3	81
SC70A-3077HD	Heavy Duty Parallel Arm	3	81
SC70A-3077FA	Forged Parallel Arm ¹	3	97
SC70A-3049FA	Hold Open Forged Parallel Arm ¹	3	121
SC70A-3077DS	Dead Stop Parallel Arm	5	99
SC70A-3049DS	Hold Open Dead Stop Parallel Arm ¹	5	121
SC70A-3077SS	Spring N Stop Arm ¹	5	162
SC70A-3049SS	Hold Open Spring N Stop Arm ¹	5	179
SC70A-18	Narrow Frame Back Plate	3	52
SC70A-18PA	Narrow Top Rail Drop Plate	4	52
SC70A-30	Cush Shoe Support	1	20
SC70A-61	Blade Stop Spacer	1	22
SC70A-62A	Offset Auxiliary Shoe	1	26

REFERENCE NOTE:

- 1) SC71A FA, FA/HO, DS/HO, SS, and SS/HO arms are not available in matte black.
- 2) Matte Black and Dark Bronze Closers share the same screw finish.

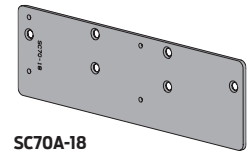

SC70A-18

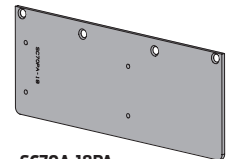

SC70A-18PA

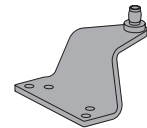

SC70A-62A

SC80A Series Closers

SC80A Series

Medium Duty

Model	Arm Type	Shipping Weight	AL (689) DKB (695) MTBK (622) ¹
SC81A	RwPA	8	195
SC81A	HwPA	8	216
SC81A	HDPA ¹	10	216
SC81A	DS	10	234
SC81A	DSHO ¹	10	255
SC81A	SS ¹	10	297
SC81A	SSHO ¹	10	314

REFERENCE NOTES:

- 1) SC81A ships standard with a SLIM Cover.
- 2) SC81A is fully adjustable 1-6

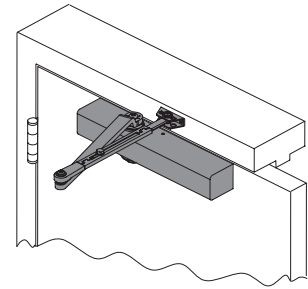

SC80A
(w/ full cover shown)

Closer Options

Suffix	Description	List Adder
FC	FULL Cover	5

Closer Parts and Accessories

Model	Description	Shipping Weight	List
SC81A-3071	Standard Cylinder	10	125
SC80A-72	Slim Cover	1	11
SC81A-72FC	FULL Cover	1	16
SC81A-3077/PA	Regular Arm w/ PA Bracket	3	60
SC81A-3049/PA	Hold Open Arm w/ PA Bracket	3	81
SC81A-3077HD	Heavy Duty Parallel Arm ¹	3	81
SC81A-3077DS	Dead Stop Parallel Arm	5	99
SC81A-3049DS	Hold Open Dead Stop Parallel Arm ¹	5	121
SC81A-3077SS	Spring N Stop Arm ¹	5	162
SC81A-3049SS	Hold Open Spring N Stop Arm ¹	5	179
SC81A-18	Mounting Plate - Top Jamb	2	31
SC81A-18FC	Mounting Plate - Top Jamb for FULL Cover	2	31
SC81A-18PA	Mounting Plate - PA	2	31
SC81A-18PAFC	Mounting Plate - PA for FULL Cover	2	31
SC81A-30	Cush Shoe Support	1	20
SC81A-61	Blade Stop Spacer	1	22
SC81A-62A	Offset Auxiliary Shoe	1	26

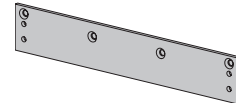

SC80A-18

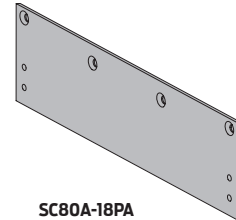

SC80A-18PA

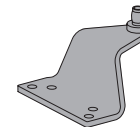

SC80A-62A

REFERENCE NOTE:

- 1) SC80A delay action, HD, DS/HO, SS, and SS/HO arms are not available in matte black.
- 2) Matte Black and Dark Bronze Closers share the same screw finish.

SC90A Series Closers

SC90A Series

Light- Residential Duty

Model	Arm Type	Size	Shipping Weight	AL (689) DKB (695)
SC91A	RwPA	1	5	114
SC91A	HwPA	1	5	135
SC93A	RwPA	3	5	114
SC93A	HwPA	3	5	135
SC94A	RwPA	4	5	114
SC94A	HwPA	4	5	135

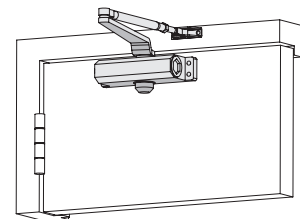

SC90A Series

REFERENCE NOTES:

- 1) SC90 series ship standard as LESS Cover.
- 2) *Brass will not be available with SC91A/SC93A/SC94A.

Closer Options

Suffix	Description	List Adder
STD	Standard Cover (Only fits 93 and 94 models)	15

Closer Parts and Accessories

Model	Description	Shipping Weight	List
SC90A-18	Mounting Plate - Top Jamb	2	31
SC90A-18PA	Mounting Plate - Push Side	2	31

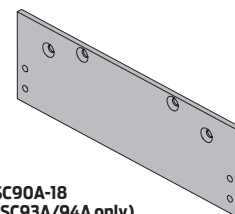

SC90A-18
(SC93A/94A only)

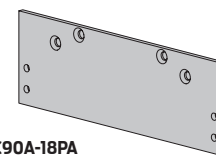

SC90A-18PA
(SC93A/94A only)

Architectural Door Hinges

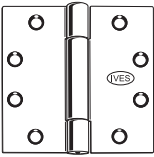

3CB1

Architectural Hinges

Number	Description	Finish	Price Each
3CB1 4.5x4.5	3 Knuckle Plain Bearing	US26D (652)	\$13.30
3CB1 4.5x4.5	3 Knuckle Concealed Bearing	US32D (630)	63.00
3CB1 4.5x4.5 NRP	3 Knuckle Concealed Bearing NRP	US26D (652)	17.55
3CB1 4.5x4.5 NRP	3 Knuckle Concealed Bearing NRP	US32D (630)	67.25
3CB1 HW 4.5x4.5	3 Knuckle Concealed Bearing Heavy Wt.	US26D (652)	45.60
3CB1 HW 4.5x4.5 NRP	3 Knuckle Concealed Bearing Heavy Wt. NRP	US26D (652)	49.85
3CB1 HW 4.5x4.5 NRP	3 Knuckle Concealed Bearing Heavy Wt. NRP	US32D (630)	100.85
3CB1 HW 5x4.5	3 Knuckle Concealed Bearing Heavy Wt.	US26D (652)	52.40
3SP1 4.5x4.5	3 Knuckle Spring	US26D (652)	24.90
5PB1 4.5x4.5	5 Knuckle Plain Bearing	US26D (652)	8.30
5PB1 4.5x4.5 NRP	5 Knuckle Plain Bearing NRP	US26D (652)	12.55
5BB1 4.5x4	5 Knuckle Ball Bearing	US26D (652)	16.40
5BB1 4.5x4 NRP	5 Knuckle Ball Bearing NRP	US26D (652)	25.40
5BB1 4.5x4.5	5 Knuckle Ball Bearing	US26D (652)	12.20
5BB1 4.5x4.5	5 Knuckle Ball Bearing	US32D (630)	44.80
5BB1 4.5x4.5	5 Knuckle Ball Bearing	USP (600)	10.90
5BB1 4.5x4.5	5 Knuckle Ball Bearing	US10B (613)	45.70
5BB1 4.5x4.5	5 Knuckle Ball Bearing	US15 (619)	45.70
5BB1 4.5x4.5	5 Knuckle Ball Bearing	US3 (632)	19.00
5BB1 4.5x4.5	5 Knuckle Ball Bearing	US4 (633)	12.20
5BB1 4.5x4.5	5 Knuckle Ball Bearing	US10 (639)	15.20
5BB1 4.5x4.5	5 Knuckle Ball Bearing	US10B (640)	19.00
5BB1 4.5x4.5	5 Knuckle Ball Bearing	US15 (646)	23.10
5BB1 4.5x4.5	5 Knuckle Ball Bearing	US26 (651)	19.00
5BB1 4.5x4.5 NRP	5 Knuckle Ball Bearing NRP	US26D (652)	16.45
5BB1 4.5x4.5 NRP	5 Knuckle Ball Bearing NRP	US32D (630)	49.05
5BB1 4.5x4.5 NRP	5 Knuckle Ball Bearing NRP	USP (600)	15.15
5BB1 4.5x4.5 NRP	5 Knuckle Ball Bearing NRP	US10B (613)	54.70
5BB1 4.5x4.5 NRP	5 Knuckle Ball Bearing NRP	US15 (619)	54.70
5BB1 4.5x4.5 NRP	5 Knuckle Ball Bearing NRP	US10B (640)	23.25
5BB1 4.5x4.5 NRP	5 Knuckle Ball Bearing NRP	US15 (646)	27.35
5BB1 5x4.5	5 Knuckle Ball Bearing	US26D (652)	25.70
5BB1 5x4.5 NRP	5 Knuckle Ball Bearing NRP	US26D (652)	34.70
5BB1 5x4.5 NRP	5 Knuckle Ball Bearing NRP	US32D (630)	66.00
5BB1 HW 4.5x4.5	5 Knuckle Ball Bearing Heavy Wt.	US26D (652)	35.40
5BB1 HW 4.5x4.5	5 Knuckle Ball Bearing Heavy Wt.	US32D (630)	73.30
5BB1 HW 4.5x4.5 NRP	5 Knuckle Ball Bearing Heavy Wt. NRP	US26D (652)	39.65
5BB1 HW 4.5x4.5 NRP	5 Knuckle Ball Bearing Heavy Wt. NRP	US32D (630)	77.55
5BB1 HW 4.5x4.5 NRP	5 Knuckle Ball Bearing Heavy Wt. NRP	US10B (613)	85.10
5BB1 HW 4.5x4.5 NRP	5 Knuckle Ball Bearing Heavy Wt. NRP	US15 (619)	79.50
5BB1 HW 5x4.5	5 Knuckle Ball Bearing Heavy Wt.	US26D (652)	40.80
5BB1 HW 5x4.5	5 Knuckle Ball Bearing Heavy Wt.	US32D (630)	85.60
5BB1 HW 5x4.5 NRP	5 Knuckle Ball Bearing Heavy Wt. NRP	US26D (652)	49.80
5BB1 HW 5x4.5 NRP	5 Knuckle Ball Bearing Heavy Wt. NRP	US32D (630)	94.60
5BB1 SC 4.5	5 Knuckle Ball Bearing Swing Clear	US26D (652)	63.90
5BB1 HW BSC 4.5	5 Knuckle Ball Bearing Heavy Wt. Beveled Swing Clear Heavy Wt.	US26D (652)	77.40
5BB1 HW BSC 5	5 Knuckle Ball Bearing Heavy Wt. Beveled Swing Clear Heavy Wt.	US26D (652)	77.40

Continuous Hinges

Number	Description	Finish	Price Each
112HD 83"	Continuous Geared, Heavy Duty 83" Length	US28	\$186.30
224HD 83"	Continuous Geared with Edge Protector, Heavy Duty, 83"	US28	198.80
700 83"	Continuous Pin & Barrel, 83"	US32D	556.70
700 95"	Continuous Pin & Barrel, 95"	US32D	644.50
705 83"	Continuous Pin & Barrel, Full Wrap, 83"	US32D	726.40

Pivots

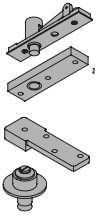

7253

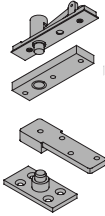

7255

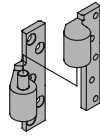

7215-7226-7227 INT

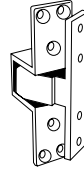

91105F

Pivot Set

Number	Description	Handing	Finish	Price Each
7215 SET RH	3/4" Offset Pivot Set, 500 lb	RH	US26D	\$427.50
7215 SET LH	3/4" Offset Pivot Set, 500 lb	LH	US26D	427.50
7226 SET	3/4" Offset Pivot Set, 600 lb	-	US26D	408.80
7230F SET	3/4" Offset Pivot Set, 1000 lb, Fire Rated	-	US32D	763.30
7253 SET	Center Hung Pivot Set, 300 lb	-	US26D	338.40
7255 SET	Center Hung Pivot Set, 500 lb	-	US26D	373.10

Note: Set includes top-and-bottom pivots.

Intermediate Pivots

Number	Description	Handing	Finish	Price Each
7215-7226-7227 INT RH	3/4" Offset Intermediate Pivot for 7215, 7226 and 7227	RH	US26D	\$231.10
7215-7226-7227 INT LH	3/4" Offset Intermediate Pivot for 7215, 7226 and 7227	LH	US26D	231.10
7230F-7237F INT RH	3/4" Offset Intermediate Pivot for 7230F and 7237F, Fire Rated	RH	US32D	427.50
7230F-7237F INT LH	3/4" Offset Intermediate Pivot for 7230F and 7237F, Fire Rated	LH	US32D	427.50

Pocket Pivot

Number	Description	Finish	Price Each
91105F	Pocket Pivot, Fire Rated	US32D	\$457.50

Note: Pocket pivots are sold individually.

Floor Stops



FS436



FS185



FS440



FS441



FS444



FS446



FS452



FS544



FS1153



FS1154

Floor Stops, Dome Stops and Kick Downs

Number	Description	Finish	Price Each
FS13	Dome Stop	US26D	\$8.50
FS436	Dome Stop	US26D	6.00
FS436	Dome Stop	US3	7.20
FS436	Dome Stop	US10B	8.30
FS436	Dome Stop	US15	8.30
FS436	Dome Stop	US26	7.50
FS436	Dome Stop	US28	5.50
FS438	Dome Stop for use with Thresholds	US26D	6.70
FS438	Dome Stop for use with Thresholds	US10B	9.70
FS438	Dome Stop for use with Thresholds	US15	9.70
FS438	Dome Stop for use with Thresholds	US26	9.10
FS438	Dome Stop for use with Thresholds	US28	6.60
R435-1/2	1/2" Riser for FS436 Dome Stop	US27	6.80
FS18L	Security Floor Stop, 3 1/2" Bumper	-	17.70
FS185	Security Floor Stop, 1 1/2" Bumper	-	12.50
FS434	Floor Stop, Angle	US2C	9.70
FS441	Floor Stop	US26D	24.20
FS441	Floor Stop	US10B	26.60
FS441	Floor Stop	US15	26.60
FS444	Floor Stop, Heavy-Duty, Masonry	US26D	28.40
FS444	Floor Stop, Heavy-Duty, Masonry	US10B	34.80
FS444	Floor Stop, Heavy-Duty, Masonry	US15	37.80
FS448	Floor Stop, Heavy-Duty, Drywall/Wood	US26D	33.10
FS448	Floor Stop, Heavy-Duty, Drywall/Wood	US10B	32.00
FS440	Floor Stop w/ Automatic Holder, 1/2" Door to Floor Clearance	US26D	66.60
FS446	Floor Stop w/ Manual Holder, Heavy-Duty, Masonry	US26D	41.60
FS446	Floor Stop w/ Manual Holder, Heavy-Duty, Masonry	US10B	52.00
FS446	Floor Stop w/ Manual Holder, Heavy-Duty, Masonry	US15	54.10
FS450	Floor Stop w/ Manual Holder, Heavy-Duty, Drywall/Wood	US26D	45.20
FS452-4"	Kick Down Holder, 4"	US26D	30.80
FS452-4"	Kick Down Holder, 4"	US15	43.80
FS452-5"	Kick Down Holder, 5"	US26D	38.20
FS452-5"	Kick Down Holder, 5"	US10B	44.30
FS452-5"	Kick Down Holder, 5"	US15	49.90
FS455-4"	Kick Down Holder, 4"	US26D	41.70
FS455-4"	Kick Down Holder, 4"	US3	34.80
FS455-4"	Kick Down Holder, 4"	US10B	41.70
FS455-4"	Kick Down Holder, 4"	US27	8.60
FS455-4"	Kick Down Holder, 4"	US3AL	8.60
FS544-4"	Kick Down Holder, 4"	SP28	12.80
FS544-4"	Kick Down Holder, 4"	SP4	12.80
FS555-5"	Kick Down Holder, 5"	SP28	13.70
FS544/555	Kick Down Holder - Rubber w/ Screw (Use P/N FSPART.1074 when ordering)		3.30
FS1153	Plunger-Type Door Holder — 1 5/8" Throw	US28	52.00
FS1154	Plunger-Type Door Holder — 1 1/4" Throw	US10	93.60

Wall Stops



Wall Stops

Number	Description	Screw Pkg.	Finish	Price Each
060F26D	Residential, Flexible Door Stop, 3"		F26D	\$1.30
060F10B	Residential, Flexible Door Stop, 3"		F10B	1.30
060F14	Residential, Flexible Door Stop, 3"		F14	1.30
060F15	Residential, Flexible Door Stop, 3"		F15	1.30
63F619E	Residential, Flexible Door Stop, 3"		63F619E	1.20
63F643E/716E	Residential, Flexible Door Stop, 3"		F643E/716E	1.20
60A92	Residential, Solid Door Stop, 3 3/4"		A92	3.70
61A92	Residential, Solid Door Stop, 3 1/8"		A92	3.70
61A10B	Residential, Solid Door Stop, 3 1/8"		A10B	3.70
61A14	Residential, Solid Door Stop, 3 1/8"		A14	3.70
61A15	Residential, Solid Door Stop, 3 1/8"		A15	3.70
61A-W	Residential, Solid Door Stop, 3 1/8"		A-W	4.10
61B15	Residential, Solid Door Stop, 3 1/8"		B15	17.80
60-5/062/70/430	Replacement Rubber Tips for 60, 61, 70 Stops (100/PKG)			90.60
69F14	Hinge Pin Door Stop (70-100 Degree Adjustment)		F14	4.80
69F15	Hinge Pin Door Stop (70-100 Degree Adjustment)		F15	4.80
70A92	Hinge Pin Door Stop (85-125 Degree Adjustment)		A92	2.50
70A-643E/716	Hinge Pin Door Stop (85-125 Degree Adjustment)		A-643E/716	2.90
70A10B	Hinge Pin Door Stop (85-125 Degree Adjustment)		A10B	2.90
70A15	Hinge Pin Door Stop (85-125 Degree Adjustment)		A15	2.90
70B10B	Hinge Pin Door Stop (85-125 Degree Adjustment)		B10B	15.80
70B15	Hinge Pin Door Stop (85-125 Degree Adjustment)		B15	15.80
WS401/402CCV	Wall Bumper, Cast, Concave	Drywall & Wood	US26D	20.80
WS401/402CVX	Wall Bumper, Cast, Convex	Drywall & Wood	US26D	20.80
WS404CVX	Wall Bumper, Compact, Convex	Drywall & Wood	US26D	7.50
WS406/407-CCV	Wall Bumper, Concave	Drywall & Wood	US32D	3.50
WS406/407-CCV	Wall Bumper, Concave	Drywall & Wood	US3	4.30
WS406/407-CCV	Wall Bumper, Concave	Drywall & Wood	US10	4.90
WS406/407-CCV	Wall Bumper, Concave	Drywall & Wood	US10B	4.90
WS406/407-CVX	Wall Bumper, Convex	Drywall & Wood	US32D	3.50
WS406/407-CVX	Wall Bumper, Convex	Drywall & Wood	US10B	4.90
WS406/407-CVX	Wall Bumper, Convex	Drywall & Wood	US15	4.90
411R-W	Wall Bumper, Adhesive Back		R-W	3.20
WS33	Wall Stop	Drywall & Wood	US26D	56.60
WS447	Wall Stop, Heavy-Duty	Drywall & Wood	US26D	42.20
WS445	Wall Stop w/ Manual Holder, Heavy-Duty	Masonry	US26D	73.60
WS40	Wall Stop w/ Automatic Holder	Universal	US26D	112.20
WS45	Wall Stop w/ Automatic Holder	Universal	US26D	156.20
FS495	Wall Stop w/ Automatic Holder		US26D	90.80
CS115-20	Crash Stop	---	US26D	52.50

Pulls and Protection Plates

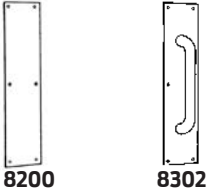

Kick Plates

Number	Size	Finish	Price Each
8400	8" x 34" B-CS	US32D	\$38.07
8400	10" x 34" B-CS	US32D	\$47.60
8400	10" x 35" B-CS	US32D	\$50.40

Push Plates

Number	Size	Finish	Price Each
8200	Push Plate 3.5x15	US32D	\$14.00
8200	Push Plate 3.5x15	US10B	30.00
8200	Push Plate 3.5x15	US15	30.00
8200	Push Plate 3.5x15	US28	11.40
8200	Push Plate 4x16	US32D	16.30
8200	Push Plate 4x16	US10B	33.90
8200	Push Plate 4x16	US15	33.90
8200	Push Plate 4x16	US26D	32.60
8200	Push Plate 4x16	US28	10.80
8200	Push Plate 6x16	US32D	22.30
8200	Push Plate 8x16	US32D	31.10

Pull Plates

Number	Size	Center to Center	Finish	Price Each
8302-6	8102 6" Pull and Plate 4x16 1 3/4"	6"	US32D	\$50.60
8302-8	8102 8" Pull and Plate 3.5x15 1 3/4"	8"	US32D	52.80
8302-8	8102 8" Pull and Plate 4x16 1 3/4"	8"	US32D	54.90
8302-0	8102 10" Pull and Plate 3.5x15 1 3/4"	10"	US32D	59.10
8302-0	8102 10" Pull and Plate 4x16 1 3/4"	10"	US32D	61.20
8303-8	8103 8" Pull and Plate 4x16 1 3/4"	8"	US32D	81.90
8303-0	8103 10" Pull and Plate 4x16 1 3/4"	10"	US32D	89.60

Pulls

Number	Size	Finish	Price Each
221B26D	Flush Pull, Large Circle	B26D	\$4.80
221B10B	Flush Pull, Large Circle	B10B	4.80
221B15	Flush Pull, Large Circle	B15	4.60
222B26D	Flush Pull, Rectangular	B26D	26.80
223B26D	Flush Pull, Oval	B26D	8.10
227B26D	Flush Pull, Deep Well	B26D	12.40
230B26D	Sliding Door Edge Pull	B26D	17.40
990B-613	Sliding Door Pull	B-613	14.60
990B-619	Sliding Door Pull	B-619	14.60
991B-613	Sliding Door Pull - Locking	B-613	20.30
991B-619	Sliding Door Pull - Locking	B-619	20.30
991B-716	Sliding Door Pull - Locking	B-716	20.30
8103HD-0	Straight 10" Pull, Heavy Duty, 1" Diameter	US32D	67.00
8103EZHD-0	Straight 10" Pull, ADA Compliant, Heavy Duty, 1" Diameter	32D-316	92.60

Offset Door Pulls

Number	Size	Center to Center	Finish	Price Each
8190HD-0	90 Degree Offset 10" Pull, Heavy Duty, 1 3/4"	10"	US32D	\$90.50
8190HD-0	90 Degree Offset 10" Pull, Heavy Duty, 1 3/4"	10"	US10B	138.60
8190HD-0	90 Degree Offset 10" Pull, Heavy Duty, 1 3/4"	10"	US15	144.30
8190HD-2	90 Degree Offset 12" Pull, Heavy Duty, 1 3/4"	12"	US32D	97.60
8190HD-0	90 Degree Offset 10" Pull, Heavy Duty, 1 3/4" (Dec. Thru-Bolt)	10"	US32D	120.50
8190HD-2	90 Degree Offset 12" Pull, Heavy Duty, 1 3/4" (Dec. Thru-Bolt)	12"	US32D	127.60
9190HD-33-0	33" Pushbar/90 Degree Offset 10" Pull, Heavy Duty, 1 3/4"	33", 10"	US32D	280.40

Vandal Resistant Trim

Vandal Resistant Trim

Number	Description	Finish	Price Each
VR910NL	Vandal Resistant Trim 98/99 Rim or Vertical Rod, Horizontal Keyway	US32D	\$301.50
VR910-DT	Vandal Resistant Trim 98/99 Rim or Vertical Rod, Blank Trim	US32D	301.50

Flush Bolts & Strikes

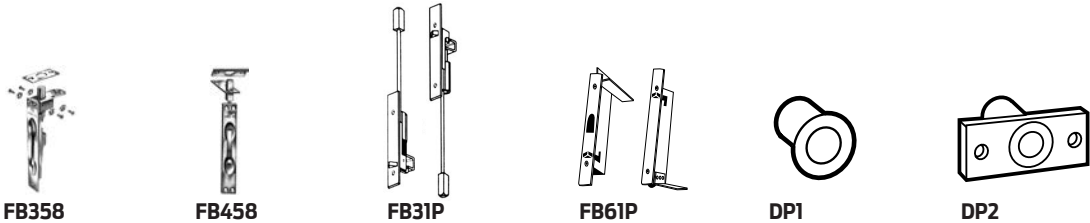

Flush Bolts

Number	Description	Door Type	Finish	Price Each
FB358	Manual Flush Bolt, Single Door	Wood	US26D	\$40.30
FB358	Manual Flush Bolt, Single Door	Wood	US10B	40.30
FB358	Manual Flush Bolt, Single Door	Wood	US15	40.30
FB457	Manual Flush Bolt, Single Door	Metal	US26D	29.90
FB458	Manual Flush Bolt, Single Door	Metal	US26D	23.50
FB458	Manual Flush Bolt, Single Door	Metal	US3	25.30
FB458	Manual Flush Bolt, Single Door	Metal	US15	25.30
FB31P	Automatic Flush Bolt, Pair	Metal	US32D	207.50
FB41P	Automatic Flush Bolt, Pair	Wood	US32D	217.00
FB51P	Constant Latching Flush Bolt, Pair	Metal	US32D	207.50
FB61P	Constant Latching Flush Bolt, Pair	Wood	US32D	219.00
262B26D	Manual Flush Bolt		B26D	36.10
262B3	Manual Flush Bolt		B3	31.40
262B10B	Manual Flush Bolt		B10B	36.10
262B	Manual Flush Bolt		B15	36.10
FB256/7/8/457/8/0458-18"	Manual Flush Bolt Rod - 18" (Use P/N 09-161 when ordering)			6.60
FB256/7/8/457/8/0458-24"	Manual Flush Bolt Rod - 24" (Use P/N 09-162 when ordering)			6.60
FB256/7/8/457/8/0458-36"	Manual Flush Bolt Rod - 36" (Use P/N 09-172 when ordering)			6.60

Dust-Proof Strikes

Number	Description	Finish	Price Each
DP1	Dust-Proof Strike – Threshold Only	US26D	\$29.30
DP2	Dust-Proof Strike – Floor and/or Threshold	US26D	36.90
DP2	Dust-Proof Strike – Floor and/or Threshold	US10B	36.90

Coordinators, Lock Guards, & Surface Bolts

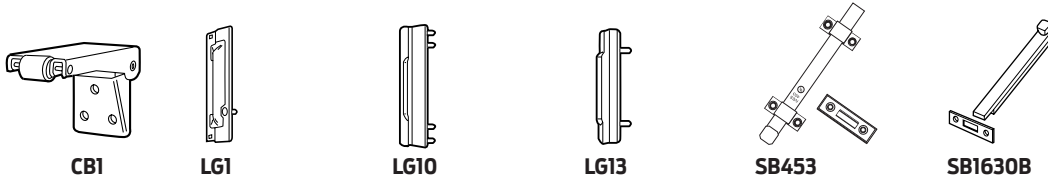

Coordinators and Accessories

Number	Description	Finish	Price Each
COR52w/FL 20	Coordinator Bar, 52" Overall Length w/ 20" Filler Bar	US28	\$181.00
COR52	Coordinator Bar, 52" Overall Length	US28	165.40
FL20	Filler Bar, 20" Overall Length	US28	15.60
MB1	Mounting Bracket – Stops over 2 1/2"	SP28	31.90
MB1	Mounting Bracket – Stops over 2 1/2"	USP	22.40
MB2	Mounting Bracket – Stops up to 2 1/2"	SP 28	36.10
MB2	Mounting Bracket – Stops up to 2 1/2"	USP	26.30
CBI	Carry Bar	USP	36.80

Lock Guards

Number	Description	Finish	Price Each
LG1	Lock Guard with Security Pin	US32D	\$46.70
LG1	Lock Guard with Security Pin	US2G	20.20
LG10	Lock Guard	US32D	43.50
LG12	Lock Guard	US32D	40.40
LG13	Lock Guard	US32D	38.80
LG14	Lock Guard	US32D	63.80

Surface Bolts

Number	Description	Finish	Price Each
40-4 B26D	4" Decorative Surface Bolt, Light Duty	B26D	\$18.70
054B26D	Dutch Door Bolt	B26D	49.20
SB360-12"	12" Surface Bolt, Heavy Duty, Universal Strike	US2C	119.20
SB453-8"-TB	8" Surface Bolt, Top and Bottom Strikes	US2C	43.40
SB1630B	8" Surface Bolt, Bottom Strike	US2G	44.80
SB1630T	8" Surface Bolt, Top Strike	US2G	49.80
SB1630TB	8" Surface Bolt, Top and Bottom Strikes	US2G	59.00

Latches & Catches

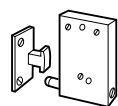

CL11

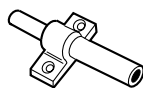

CL14

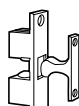

CL21A

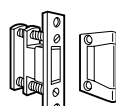

RL30

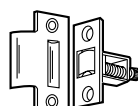

RL36

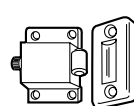

RL38

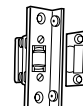

RL1152



SR64

Roller Latches, Invisible Latches, and Ball-Type or Cabinet Catch

Number	Description	Finish	Price Each
RL30	Roller Latch, High traffic	US26D	\$72.90
RL32	Roller Latch, Light-Duty, Mortise	US26D	98.40
RL36	Roller Latch, Light-Duty, Mortise	US32D	55.50
RL38	Roller Latch, Light-Duty, Surface Mounted	US32D	52.40
RL1152	Roller Latch with Angle Stop	US26D	145.10
CL11	Invisible Latch, 7/16" x 1 1/4" x 1 7/8"	US26D	37.50
CL12	Invisible Latch, 9/16" x 1 1/4" x 2 1/4"	US26D	45.60
CL14	Invisible Latch Auxiliary Pusher	US26D	39.70
CL21A	Ball Catch, Four-Way, Full Size Doors	US26D	36.90
CL22	Ball Catch, Three-Way, Smaller Doors	US26D	24.90
325A92	Magnetic Catch, Light Duty, Single Magnet	A92	3.30
326A92	Magnetic Catch, Heavy Duty, Two Magnet	A92	9.20
327A92	Magnetic Catch, Heavy Duty, Four Magnet	A92	15.70
335B10B	Roller Catch, Adjustable	B10B	18.70
336B15	Roller Catch Adjustable	B15	18.70
347B26D	Ball Catch, Square Corners	B26D	15.50
347B10B	Ball Catch, Square Corners	B10B	15.50
347B15	Ball Catch, Square Corners	B15	14.80
347B26	Ball Catch, Square Corners	B26	15.50
349B26D	Ball Catch, Round Corners	B26D	16.20
349B3	Ball Catch, Round Corners	B3	13.70
349B15	Ball Catch, Round Corners	B26	16.80
2A92	Cabinet Catch, Elbow	A92	4.30
2A3	Cabinet Catch, Elbow	A3	4.30
42B10B	Pocket Door Bolt	B10B	17.30
42B15	Pocket Door Bolt	B15	16.60
42B26	Pocket Door Bolt	B26	17.30

Door Silencers

Number	Description		Finish	Price Each
SR64	Door Silencers for Metal Frames, Bag of 100	Metal	Gray	\$35.40
SR65	Door Silencer for Wood Frames, Bag of 100	Wood	Gray	35.40

Miscellaneous Hardware

Hooks

Number	Description	Finish	Price Each
405	Coat & Hat Hook	A92	\$2.70
571	Coat & Hat Hook	A92	1.30
571	Coat & Hat Hook	A3	1.30
571	Coat & Hat Hook	B10B	10.30
571	Coat & Hat Hook	B15	10.90
572	Coat & Hat Hook	B26D	14.30
580	Ceiling Hook	A92	3.00
581	Wardrobe Hook	A92	1.70
582	Double Wardrobe Hook	A92	1.90
582	Double Wardrobe Hook	B26D	9.30

Viewer

Number	Description	Finish	Price Each
U696B26D	One Way Viewer, UL Listed	B26D	\$17.10
698	One Way Viewer, Wide Angle	B26D	20.10
U698B26D	One Way Viewer, Wide Angle, UL Listed	B26D	24.10
U698B3	One Way Viewer, Wide Angle, UL Listed	B3	24.10
700B26D	One Way Viewer, Narrow Angle	B26D	8.60
U700B26D	One Way Viewer, Narrow Angle, UL Listed	B26D	11.70

Door Guard

Number	Description	Finish	Price Each
482	Door Guard, Solid Bar	B26D	\$36.90

Window Lock

Number	Description	Finish	Price Each
07B3	Window Lock	B3	\$17.50
07B15	Window Lock	US15	\$22.10

Handrail Bracket

Number	Description	Finish	Price Each
059A92	Handrail Bracket	A92	\$3.90
059A-BLK	Handrail Bracket	A-BLK	5.20
059A-W	Handrail Bracket	A-W	5.20
59A3	Handrail Bracket	A3	4.00
59A15	Handrail Bracket	A15	5.10
59B15	Handrail Bracket	B15	27.40
59A716	Handrail Bracket	A716	5.10
HB159	Handrail Bracket	US27	17.90

Schlage Residential Barn Door Hardware



J-Strap

Description	Finish	Track Length	SKU	Price	Special Order
SD10-6.6 619 JSTP N N SL, Satin Nickel J-Strap	619	6ft 6in	043156002634	\$275.00	
SD10-6.6 622 JSTP N N SL, Black J-Strap	622	6ft 6in	043156002641	\$174.00	
SD10-6.6 630 JSTP N N SL, Stainless Steel J-Strap	630	6ft 6in	043156002658	\$347.00	
SD10-6.6 716 JSTP N N SL, Aged Bronze J-Strap	716	6ft 6in	043156002672	\$268.00	
SD10-8.0 619 JSTP N N SL, Satin Nickel J-Strap	619	8ft	043156002832	\$283.00	
SD10-8.0 622 JSTP N N SL, Black J-Strap	622	8ft	043156002849	\$179.00	
SD10-8.0 630 JSTP N N SL, Stainless Steel J-Strap	630	8ft	043156002856	\$354.00	
SD10-8.0 716 JSTP N N SL, Aged Bronze J-Strap	716	8ft	043156002870	\$265.00	

J-Strap - Extended Lead Time

SD10-6.6- Dark Bronze (690) J-Strap	690	6ft 6in	043156002665	\$174.00	Extended Lead Time
SD10-8.0- Dark Bronze (690) J-Strap	690	8ft	043156002863	\$181.00	Extended Lead Time

13 week lead time, 50 unit minimum order.

Top Mount

Description	Finish	Track Length	SKU	Price	Special Order
SD10-6.6 619 TMNT N N SL, Satin Nickel Top Mount	619	6ft 6in	043156002788	\$275.00	
SD10-6.6 622 TMNT N N SL, Black Top Mount	622	6ft 6in	043156002795	\$174.00	
SD10-6.6 630 TMNT N N SL, Stainless Steel Top Mount	630	6ft 6in	043156002801	\$347.00	
SD10-6.6 716 TMNT N N SL, Aged Bronze Top Mount	716	6ft 6in	043156002825	\$268.00	
SD10-8.0 619 TMNT N N SL, Satin Nickel Top Mount	619	8ft	043156002986	\$283.00	
SD10-8.0 622 TMNT N N SL, Black Top Mount	622	8ft	043156002993	\$179.00	
SD10-8.0 630 TMNT N N SL, Stainless Steel Top Mount	630	8ft	043156003006	\$354.00	
SD10-8.0 716 TMNT N N SL, Aged Bronze Top Mount	716	8ft	043156003020	\$265.00	

Top Mount - Extended Lead Time

SD10-6.6- Dark Bronze (690) Top Mount	690	6ft 6in	043156002818	\$174.00	Extended Lead Time
SD10-8.0- Dark Bronze(690) Top Mount	690	8ft	043156003013	\$181.00	Extended Lead Time

13 week lead time, 50 unit minimum order.

Schlage Residential Sliding Door Hardware (continued)

**Decorative Strap**

Description	Finish	Track Length	SKU	Price	Special Order
SD10-6.6- Satin Nickel (619) Decorative Strap	619	6ft 6in	043156002733	\$275.00	Extended Lead Time
SD10-6.6- Black (622) Decorative Strap	622	6ft 6in	043156002740	\$174.00	Extended Lead Time
SD10-6.6- Stainless Steel (630) Decorative Strap	630	6ft 6in	043156002757	\$347.00	Extended Lead Time
SD10-6.6- Aged Bronze (716) Decorative Strap	716	6ft 6in	043156002771	\$268.00	Extended Lead Time
SD10-6.6- Dark Bronze (690) Decorative Strap	690	6ft 6in	043156002764	\$174.00	Extended Lead Time
SD10-8.0- Satin Nickel (619) Decorative Strap	619	8ft	043156002931	\$283.00	Extended Lead Time
SD10-8.0- Black (622) Decorative Strap	622	8ft	043156002948	\$179.00	Extended Lead Time
SD10-8.0- Stainless Steel (630) Decorative Strap	630	8ft	043156002955	\$354.00	Extended Lead Time
SD10-8.0- Aged Bronze (716) Decorative Strap	716	8ft	043156002979	\$265.00	Extended Lead Time
SD10-8.0- Dark Bronze (690) Decorative Strap	690	8ft	043156002962	\$181.00	Extended Lead Time

13 week lead time, 50 unit minimum order.

I-Strap

Description	Finish	Track Length	SKU	Price	Special Order
SD10-6.6- Satin Nickel (619) I-Strap	619	6ft 6in	043156002689	\$275.00	Extended Lead Time
SD10-6.6- Black (622) I-Strap	622	6ft 6in	043156002696	\$174.00	Extended Lead Time
SD10-6.6- Stainless Steel (630) I-Strap	630	6ft 6in	043156002702	\$347.00	Extended Lead Time
SD10-6.6- Aged Bronze (716) I-Strap	716	6ft 6in	043156002726	\$268.00	Extended Lead Time
SD10-6.6- Dark Bronze (690) I-Strap	690	6ft 6in	043156002719	\$174.00	Extended Lead Time
SD10-8.0- Satin Nickel (619) I-Strap	619	8ft	043156002887	\$283.00	Extended Lead Time
SD10-8.0- Black (622) I-Strap	622	8ft	043156002894	\$179.00	Extended Lead Time
SD10-8.0- Stainless Steel (630) I-Strap	630	8ft	043156002900	\$354.00	Extended Lead Time
SD10-8.0- Aged Bronze (716) I-Strap	716	8ft	043156002924	\$265.00	Extended Lead Time
SD10-8.0- Dark Bronze (690) I-Strap	690	8ft	043156002917	\$181.00	Extended Lead Time

13 week lead time, 50 unit minimum order.

Track Adapter

Description	Finish	SKU	Price	Special Order
SD10 619 ADPTR N N SL, Satin Nickel Track Adapter	619	043156003051	\$14.40	
SD10 622 ADPTR N N SL, Black Track Adapter	622	043156003068	\$12.30	
SD10 630 ADPTR N N SL, Stainless Steel Track Adapter	630	043156003075	\$15.00	
SD10 716 ADPTR N N SL, Aged Bronze Track Adapter	716	043156003099	\$14.40	
SD10 Dark Bronze (690) Track Adapter	690	043156003082	\$12.30	Extended Lead Time

13 week lead time, 50 unit minimum order.