



**KABA®**

# SIMPLEX® 3000 NARROW STILE

Installation Instructions

# TABLE OF CONTENTS

---

Package Contents .....	2
Tools Required .....	2
A. Combination Lock Assembly .....	3
B. Mounting Lock to Stile .....	4
C. Operating Instructions .....	6
Warranty .....	8
D. Combination Change Information .....	9
E. Resetting an Unknown Combination .....	11

---

## Warnings and Cautions

**Important:** Carefully inspect windows, doorframe, door, etc. to ensure that the recommended procedures will not cause any damage. Kaba Access Control's warranty does not cover damages caused by installation.

**Caution:** Wear safety glasses when preparing door.

## PACKAGE CONTENTS

- Combination lock assembly
- Instructions for changing combination
- Operating instructions
- Warranty card
- DF-59 keys
- Mounting screws 10-24 thd. X 2 1/8"
- Inside trim plate assembly
- Cylinder groove screws #4 self-tapping screw
- Optional cylinder guard (3002 models only)
- Cam stop screw 6-32 thd. X 3/16" long

## TOOLS REQUIRED FOR INSTALLATION:

- Flat blade screwdrivers (small and medium)
- Phillips head screwdriver (large)
- Tape
- Hammer
- Deburring tool
- Drill (variable speed recommended)
- Center punch
- (3/32") drill bit
- (3/8") drill bit
- (1/8") drill bit
- (1/4") drill bit
- (7/8") hole saw

# A. COMBINATION LOCK ASSEMBLY

- A-1** Cylinder Installation: Remove interposer assembly (A) by removing one round head screw and one flat head screw (See Figure 1-1).
- A-2** Install Mortise cylinder by turning cylinder until cylinder cam (E) contacts lock-in plate (B) (See Figure 1-1). Turn cylinder to the left (counterclockwise) less than one turn until the key is positioned in pull position (See Figure 1-2), also aligning to cylinder set screw grooves (See Figure 1-1).
- A-3** Assemble two cylinder positioning screws (C). Make sure the heads of these screws are below the underside of the cylinder cam (See Figure 1-1).
- A-4** Reassemble the interposer assembly (A). Interposer arm should be positioned central to the cylinder cam (See Figure 1-3).
- A-5** Assemble cam stop screw (D).

**Note:** Interposer stud to be centered before mounting combination lock assembly (See Figure 1-1).

Partial Rear View of Narrow Stile Lock Assembly

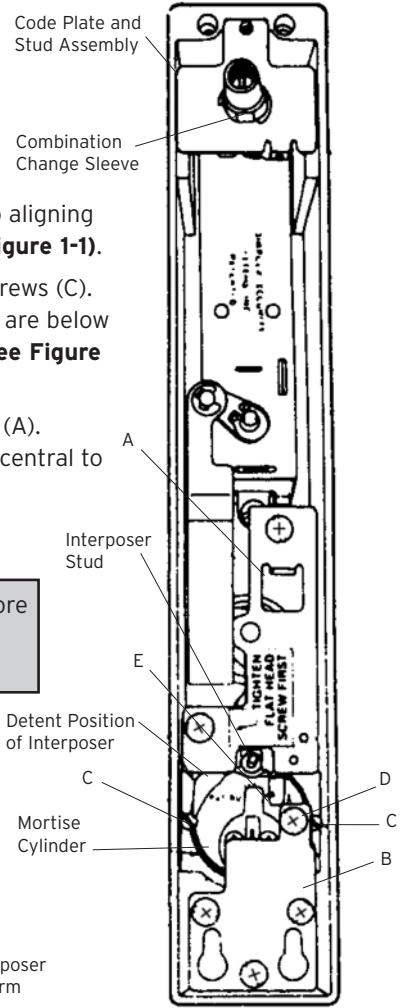

Figure 1-1

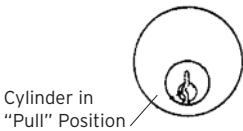

Figure 1-2

Side View

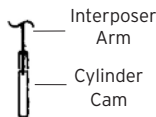
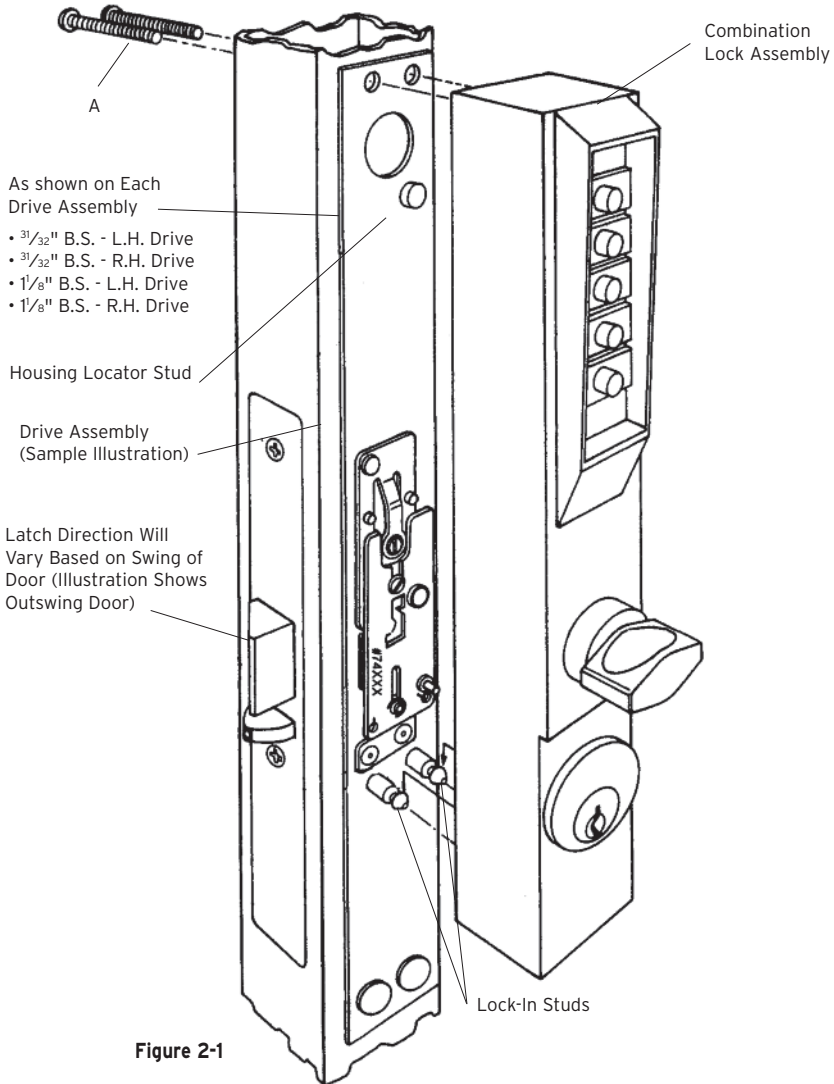

Figure 1-3

## B. MOUNTING LOCK TO STILE

**B-1** Place combination lock assembly over lock-in studs and slide downward until a stop position is attained (approximately  $\frac{1}{8}$ " of movement) (See **Figure 2-1**). The top of the lock housing and drive assembly should be flush when properly positioned.

**Note:** Before closing door, refer to operating instructions to check out the operation of all lock functions.



**B-2** Fix two each 10-24 x 2 1/8" long round head machine screws (A) as shown (See Figures 2-1 & 2-2). Using the DF-59 key, thread the control lock assembly (B) into the combination change sleeve (C) DF-59 (See Figure 2-2) until trim plate is snug against stile. The key can only be removed in vertical position.

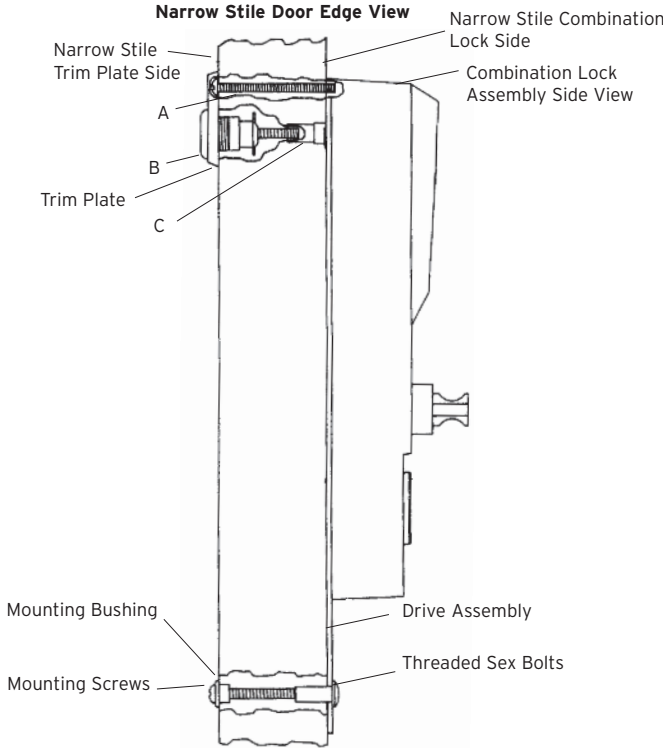

**Figure 2-2**

## C. OPERATING INSTRUCTIONS

**Note:** All locks are shipped with the following combination: #2 and #4 pushed at the same time, then #3. For proper security, the factory set code must be changed at the time of installation.

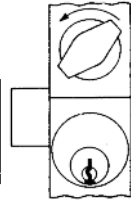

Figure 3-1

### C-1 Gaining Access By Combination Code

- A. To clear any previously depressed code buttons, turn the thumb turn to the left (counterclockwise) and release (**See Figure 3-1**).
- B. Depress the code buttons in the proper order of your combination. Release buttons after depressing.
- C. Turn the thumb turn clockwise to the stop position. Observe the latch being retracted to unlock the door (**See Figure 3-2**). The lock will lock automatically when the thumb turn is released.

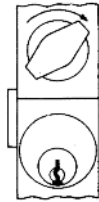

Figure 3-2

### C-2 Gaining Access By Key Override

Insert cylinder key into cylinder on combination lock side of door. Turn the key in clockwise direction (approximately 90°) (**See Figure 3-3**). The latch should retract. Turn the key back to key pull position and remove.

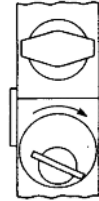

Figure 3-3

### C-3 Locking Out Combination Code Access

- A. Insert cylinder key into cylinder on combination lock side of the door. Turn key in a counterclockwise direction to the stop position (**See Figure 3-4**). Return the key to the pull position and remove. The thumb turn should not turn while the lock is in this mode.
- B. To allow access again through a combination code, insert key, turn clockwise approximately 45°. Return the key to the pull position and remove (**See Figure 3-5**).

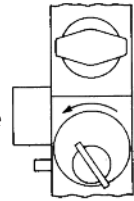

Figure 3-4

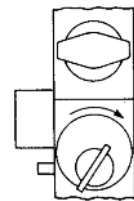

Figure 3-5

#### C-4 Latch Holdback

**A.** Insert cylinder key into cylinder on combination lock side of the door. Turn the key in a clockwise direction to the stop position, retracting the latch fully (**See Figure 3-6**). Hold the key in that position and turn the thumb turn to the left (counterclockwise). Bring the key to the pull position and remove.

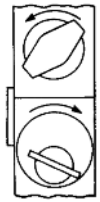

Figure 3-6

**B.** To allow the latch to return to lock mode, reinsert and turn the key to the left (counterclockwise) to the stop position (**See Figure 3-7**). Return the key to the pull position and remove (**See Figure 3-8**).

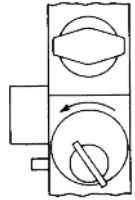

Figure 3-7

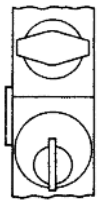

Figure 3-8

# KABA SIMPLEX® LIMITED WARRANTY

---

Kaba Access Control warrants this product to be free from defects in material and workmanship under normal use and service for a period of one (1) year. Kaba Access Control will repair or replace, at our discretion, Simplex Locks found by Kaba Access Control analysis to be defective during this period. Our only liability, whether in tort or in contract, under this warranty is to repair or replace products that are returned to Kaba Access Control within the one (1) year warranty period.

This warranty is in lieu of and not in addition to any other warranty or condition, express or implied, including without limitation merchantability, fitness for purpose or absence of latent defects.

**ATTENTION:** This warranty does not cover problems arising out of improper installation, neglect or misuse. All warranties implied or written will be null and void if the lock is not installed properly and /or if any supplied component part is substituted with a foreign part. If the lock is used with a wall bumper, the warranty is null and void. If a doorstop is required, we recommend the use of a floor secured stop.

The environment and conditions of use determine the life of finishes on Kaba Access Control products. Finishes on Kaba Access Control products are subject to change due to wear and environmental corrosion. Kaba Access Control cannot be held responsible for the deterioration of finishes.

## **Authorization to Return Goods**

Returned merchandise will not be accepted without prior approval. Approvals and Returned Goods Authorization Numbers (RGA Numbers) for the Simplex 3000 Series are available through our Customer Service department in Winston-Salem, NC 800.849.8324 **The serial number of a lock is required to obtain this RGA Number.** The issuance of an RGA does not imply that a credit or replacement will be issued.

The RGA number must be included on the address label when material is returned to the factory. All component parts including latches and strikes (even if not inoperative) must be included in the package with return. All merchandise must be returned prepaid and properly packaged to the address indicated.



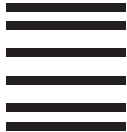

NO POSTAGE  
NECESSARY  
IF MAILED  
IN THE  
UNITED STATES

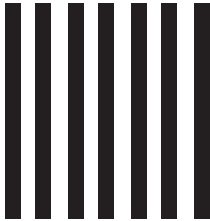

**BUSINESS REPLY MAIL**

FIRST-CLASS MAIL

PERMIT NO. 1563

WINSTON-SALEM, NC

POSTAGE WILL BE PAID BY ADDRESSEE

KABA ACCESS CONTROL  
2941 INDIANA AVENUE  
WINSTON-SALEM, NC 27199-3770



## REGISTRATION CARD

Thank you for purchasing our product. In order to protect your investment and to enable us to better serve you in the future, please fill out this registration card and return it to Kaba Access Control, or register online at [www.kabaaccess.com](http://www.kabaaccess.com).

Name \_\_\_\_\_

Position \_\_\_\_\_

Company \_\_\_\_\_

Address \_\_\_\_\_

City \_\_\_\_\_

State \_\_\_\_\_ ZIP (Postal Code) \_\_\_\_\_ Country \_\_\_\_\_

Phone \_\_\_\_\_

Email \_\_\_\_\_

Name of Dealer Purchased From \_\_\_\_\_

Date of Purchase \_\_\_\_\_

Lock Model Number \_\_\_\_\_

### This lock will be used in what type of facility?

- Commercial Building     Industrial/Manufacturing     Airport
- College/University     Government/Military     School/Educational
- Hospital/Healthcare     Other (please specify) \_\_\_\_\_

### What area is being secured with this lock? (e.g. Front Door, Common Door, Exercise Room)

\_\_\_\_\_

This lock is:

- New Installation
- Replacing a conventional keyed lock
- Replacing a Kaba Mechanical Pushbutton Lock
- Replacing a Kaba Electronic Access Control
- Replacing a Keyless Lock other than Kaba

### How did you learn about Kaba Access Control Pushbutton Locks?

- Advertisement     Previous Use     Internet/Web     Another Use
- Locksmith     Maintenance     Training Class     Other (please specify)

What was your reason for buying this lock? \_\_\_\_\_

\_\_\_\_\_

### Who installed your lock?

- Locksmith     Maintenance     Other \_\_\_\_\_

Check here if you would like more information on Kaba Access Control locks.

## D. COMBINATION CHANGE INFORMATION

**Important:** Read all instructions before beginning.

**D-1 Changing Combinations:** In order to change an existing combination, you must:

1. Have a DF 59 Key
2. Know the existing combination
3. Have lock set for pushbutton access to retract latch
4. Have a small flat 1/8" blade screwdriver
5. Keep the door open during combination change procedure

**D-2** Any or all buttons in any order, separately and/or pushed at the same time can be used in your new combination. Each button can only be used once in the combination.

**D-3** Remove the control lock assembly and trim plate using the DF 59 key provided, exposing combination change sleeve as shown (**See Figure 4-1**). Key must be turned to the left (counterclockwise rotation until control lock assembly can be removed from lock).

**D-4** Turn outside thumb turn counterclockwise (to the left) to stop position and release (**See Figure 4-2**). This will clear the lock of previously depressed buttons.

**D-5** Depress the buttons in the existing combination making certain each button is fully depressed and released.

**D-6** Insert the screwdriver into combination change sleeve slot (**See Figure 4-1**). Gently turn the screwdriver to the right (clockwise) to the stop position, making sure not to force it. A slight click should be felt/heard. Turn the screwdriver to the left (counterclockwise) to the stop, then remove.

**D-7** Clear the lock of old combination by turning the thumb turn to the left (counterclockwise) to the stop position. Release the knob.

**D-8** Depress the buttons of desired combination carefully, making sure that a click is felt with each button(s) that is depressed, and release.

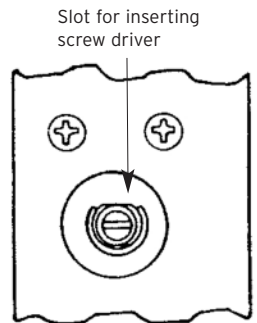

Partial rear view of combination change sleeve

**Figure 4-1**

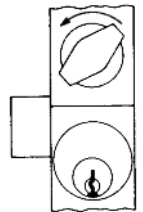

**Figure 4-2**

**D-9** Turn the thumb turn clockwise to the stop position, assuring the latch is retracted (**See Figure 4-3**). Release thumb turn. You should not be able to turn the thumb turn unless you have depressed the buttons of your newly entered combination. The new combination is now programmed in the lock.

**D-10** Replace control lock assembly and trim plate by inserting threaded rod portion into the combination change sleeve and turning to the right (clockwise) until trim plate is snug against the stile of door. The DF 59 key can be removed from control lock assembly in the vertical position only.

**D-11** Before closing door, activate new combination and turn the thumb turn to the right (clockwise) to ensure proper retraction of the latch (**See Figure 4-4**).

**Warning:** If you can turn the thumb turn to the right (clockwise) without pressing any combination, you are in a "0" combination because some steps above were performed out of order. To reset a combination, follow the above steps, but omit D-5.

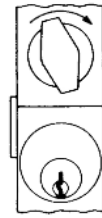

Figure 4-3

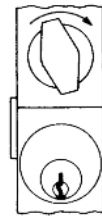

Figure 4-4

## E. RESETTING AN UNKNOWN COMBINATION

Remove the combination chamber, held by 2 screws, from the lock.

To remove the 3-sided dust cover marked "Kaba," "Simplex," etc. place the combination chamber in the position to the right.

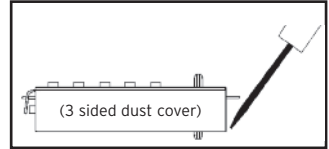

Figure 5-1

**E-1** Place a small screwdriver on the edge of the 3-sided dust cover and push down on the screwdriver (See Figure 5-1). The cover should pop loose. Once it does, pull the cover off of the combination chamber.

**E-2** Hold the chamber in one hand by the screw tab (b) on each end with the key-stems (c) facing you and the control shaft (d) at the bottom (See Figure 5-2).

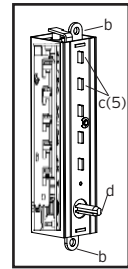

Figure 5-2

**E-3** Using pliers or equivalent, rotate the control shaft (d) counterclockwise and release to clear the chamber (See Figure 5-2).

**E-4** Look at the 5 code gears (e). If any code gear pockets (f) are already at the shear line (open position), ignore them. They are not used in the combination (See Figure 5-3).

**Note:** Shear line (open position) references the "L" shaped feet already align with the mating gear pocket.

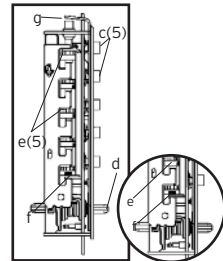

Figure 5-3

**E-5** Find the code gear pocket/s (e) that is farthest away from the shear line (open position). Depress that key-stem/s (c) and release (See Figure 5-3). If any digits in the combination were depressed together (at the same time), then they must also be depressed together to reset the combination.

**E-6** Find the code gear pocket/s (e) that is the next farthest away from the shear line (open position). Depress that key-stem/s (c) and release (See Figure 5-3).

**Note:** If any of the code gear pockets travel past the shear line, the key stems have been depressed in the wrong sequence. Start over at E-3.

**E-7** Repeat step E-6 until all code gear pockets (e) are at the shear line (open position).

**E-8** If all the code gear pockets (e) are not lined up at the shear line (open position), start over at step E-3.

**E-9** Depress the lockout slide (g) at the top of the chamber and release. (looks like one end of a spark plug)  
**(See Figure 5-4).**

**E-10** Using pliers or equivalent, rotate the control shaft (d) counterclockwise to clear the chamber and release. The lockout slide (g) should pop out (button will stay depressed) **(See Figure 5-4).**

**E-11** Depress the key-stem/s (c) that you want in the new combination, releasing each after it is depressed  
**(See Figure 5-2).**

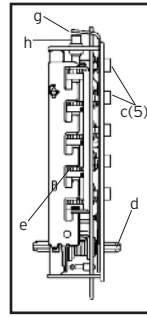

**Figure 5-4**

**E-12** Once all the digits in the new combination have been depressed, with pliers or equivalent, rotate the control shaft (d) clockwise **(See Figure 5-4)**. The code change button (h) underneath the lockout slide (g), should pop up **(See Figure 5-4)**. The new combination is now set.

**E-13** Look at the code gear pockets (e). The digits in the new combination should not be at the shear line (open position) **(See Figure 5-3)**.

**Reinstallation:** Replace the 3-sided dust cover marked "Kaba," "Simplex," etc. Make sure the staked joints on both end plates fit through the slots on the dust cover. Stake the 2 end plate joints. Replace the combination chamber into the lock using the same 2 screws removed earlier. Replace any other components removed earlier during this process. Reinstall the lock assembly to the door.

**Testing:** Enter the combination set during the reset process. Turn the outside thumbturn to the right (clockwise). The latch should retract. If the latch does not retract, turn the outside thumbturn left (counterclockwise) and release. Enter the combination again, and turn the thumbturn to the right (clockwise). If still unsuccessful, start over at step E-1.

**KABA®**

For technical assistance please call  
1.800.849.TECH (8324) or 336.725.1331

## Notes

---

---

---

---

---

---

---

---

---

---

---

---

---

---

---

---

---

---

---

---

---

---

---

---



**Kaba Access Control**

2941 Indiana Avenue

Winston-Salem, NC 27105 USA

Tel: 800.849.8324 or 336.725.1331

Fax: 800.346.9640 or 336.725.3269

[www.kabaaccess.com](http://www.kabaaccess.com)

PKG2586 0709