



ALARM LOCK

345 Bayview Avenue
Amityville, New York 11701
For Sales and Repairs, (800) 645-9445
For Technical Service, (800) 645-9440
© ALARM LOCK 2006

PG21 Series Pilfergard Door Alarms



INSTALLATION INSTRUCTIONS

Publicly traded on NASDAQ Symbol: NSSC

WI738F 1/06

DESCRIPTION

The PG21 is a microprocessor-controlled door alarm for surface mounting on a door or door frame. Typical applications include emergency fire escape doors, nursing home stairwell doors, rear restaurant and theater doors. The PG21 is designed to continually monitor the status of a door. When opened, the protected door triggers an alarm sounder, an optional strobe or can activate another device via a Form-C relay. It has various programmable features including:

- Four Siren Sounds
- Four "Alarm Modes" for a variety of applications (see page 5).
- Programmable Time Delays
- Battery Operated (Battery life approximately 2 ½ years)
- External Power Supply Capability
- Built-in Door Bell (Requires button installation)
- Cover Tamper Protection (Unauthorized removal trips alarm)
- "Key Lock Tamper" (Cover cannot be removed without key)
- Accepts standard mortise cylinders
- Multiple Door Monitoring (External Reed Switch Contacts)
- Form-C Relay (Connect to fire/burglary panel or other device)
- Annunciator Feature (Beeps when door opens)
- Two Operating Modes: "Always Armed" and "On/Off"
- Strobe Feature (PG21MSS models only)
- Status Indicator

The PG21 unit is usually mounted on the interior of the door frame or door and is paired with a magnet (*Magnetic Actuator*) mounted on the opposing side of the door gap. Opening the door, when armed, will activate the alarm. The PG21 is shipped from the factory in "Always Armed" mode (if key is removed, unit automatically re-arms) and can be converted to a manual "On/Off" mode (allowing the operator to manually arm or disarm with the key). The Status indicator (located on the front of the Housing Cover) signifies whether the unit is armed or disarmed (red indicates armed status). A selectable *annunciator* feature beeps to signal the opening of the door while the unit is disarmed.

SPECIFICATIONS

Dimensions: 11" x 2½" x 2 3/8" (22.8cm x 6.3cm x 6.8cm) (LxWxD) (Length 11" with Strobe, 9" without Strobe).

Finish: Metallic Silver (PG21MS); Metallic Bronze (PG21MB); Red (PG21RD); Metallic Silver with Strobe (PG21MSS)

Power Requirements: 9-Volt Alkaline Battery (supplied). The PG21 may also be used with Model PP100 (optional) or other power supply providing 9-12Vdc at 300mA. Internal battery may be used simultaneously

with external power supply.

Sounding Device: Piezo electronic sounder sweep siren, steady or pulsing, 110dB at 10 feet

Shipping Weight: 1 lb, 10 oz.

Relay Contacts: (Form-C) rated at 24VAC/DC at 1A (non-inductive).

A. INSTALLATION: PRELIMINARY STEPS

Installation is divided into 5 main steps: (A) Preliminary, (B) Wiring, (C) Configuration, (D) Mounting and (E) Testing.

1. **Choose a suitable location.** Most often, the PG21 is mounted on a door, and the Magnetic Actuator is mounted to (or inside) the door jamb. However, if the PG21 will have a doorbell or any external wiring, give careful consideration to the mounting location and make allowances for all necessary wiring. For example, if you wish to monitor multiple doors, choose a generally central location as wires (and reed switch contacts) will need to run to all doors in series. If you mount the PG21 on a door, the Baseplate must be mounted far enough away from the edge of the door to prevent unit from striking the door jam when opening the door.
2. **Examine the enclosed template.** The two-sided template provides mounting hole locations (drawn in solid circular lines) for several door types. Use the four corner holes for the Baseplate as shown on the template. **Note:** Certain narrow-stile doors require only two holes for the Baseplate.
3. **Mark and drill holes** (use 1/8" bit, 1" deep) on the door and jamb as per the template directions. Hole locations are drawn in solid circular lines.
4. **External Wiring.** Mark and drill the hole (shown on the template) for external wiring such as doorbell, reed switch or relay wiring.
5. **Knock out the necessary holes** from the Baseplate and install on the door with the supplied #8 sheet-metal screws.
6. **Temporarily mount the Housing Cover** into the Baseplate to aid in positioning the Magnetic Actuator location. Mount as follows: Remove all keys from cylinder (thus ensuring the cylinder is in a 12:00 position). Hold the Housing Cover vertically with the inside facing toward you (the PC board and jumpers can be seen at bottom), *slide the switch to the right*. (**Note:** Each time the Housing Cover is removed, the switch **MUST** be moved to the right before mounting). Hook the Housing Cover into the clip at the bottom of the Baseplate, then gently snap the top of the Housing cover into the top of the Baseplate. **DO NOT FORCE.** **Note:** If the switch is in the wrong position (not moved to the right), or if a key is accidentally left inside the cylinder, the Housing Cover is specifically designed **NOT** to lock into the Baseplate.

7. **Position the Magnetic Actuator** as indicated by the red sticker on the side of the Housing Cover. If stickers were removed, use the Magnet Alignment Mode (see page 3) or place the Magnetic Actuator 1½" from the bottom edge of the Baseplate. Mark holes and (as with the Baseplate) use a 1/8" (0.125") bit, and drill the hole 1" deep.
8. **Install the Magnetic Actuator** with the supplied #8 sheet-metal screws (1"). Be sure to insert the Magnet (P1358) and Magnet Cover (P0291) into the Magnet Housing (P0290) before mounting.

B. WIRING

External wiring to the PG21 requires that the unit be mounted on the frame with the magnet on the adjacent door. (The PG21 may be mounted on a door with the addition of a Model 271 Flexible Cable). All wiring is made at its terminal strip. Wiring connections are summarized in the Wiring Diagram shown below in Figure 1.

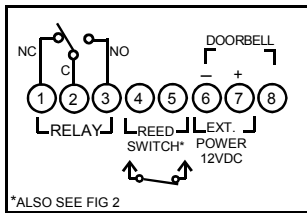

Fig 1. Wiring Diagram.

Relay (Terminals 1-3). Terminal 1 = Normally Closed; Terminal 2 = Common; Terminal 3 = Normally Open. On alarm, the relay will activate and remain latched for as long as the sounder is on.

Reed Switch (Terminals 4 & 5). Connect external reed switch contacts to Terminals 4 and 5 and remove reed selection jumper W1 located in the center of the PCB. **Note:** If reed switches are wired in series as shown below in Figure 2, several doors may be monitored simultaneously. Using #22AWG wire, maximum wiring distance should not exceed 50 feet. **Note:** When external reed switches are used, the internal reed switches must be disabled by removing the reed selection (W1) jumper.

Power (Terminals 6 & 7). Connect an external power supply: positive (+) red to Terminal 7; negative (-) black to Terminal 6. Leave in the internal battery as a backup battery. If using the Alarm Lock PP100 Power Supply,

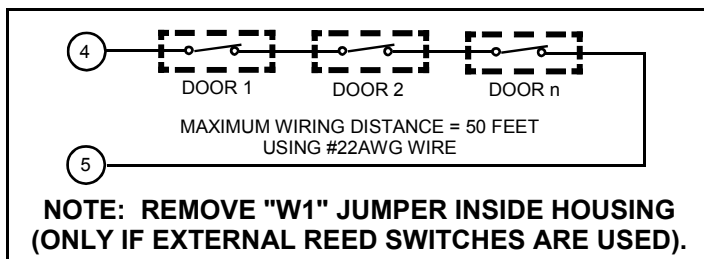

Fig. 2. Multiple door monitoring (wired in series).

connect the two battery clips to the unit and the internal battery as labeled.

Doorbell (Terminal 8). Connect between terminal 8 and 6 using momentary-on switch to activate Doorbell. Produces alternating tone. Will not operate during Alarm or during Arm delays. **Note:** Do not use a lighted door bell button--the light will drain the battery.

Strobe Connector (Jumper 14). If using a Strobe unit, run the wires through Strobe Assembly and Palnut and plug female polarized connector into J14 located in the center of the PC board (see Fig 5b, page 4). **Note:** J14 (Pin1) is the external Strobe Power (9 volts) and J14 (Pin2) is the Strobe Ground.

The Strobe and siren are on the same circuit, therefore the timeout duration is the same for both.

C. CONFIGURATION

There are two configuration sections: Mechanical Configuration and Jumper ("Software") Configuration.

Mechanical Configuration

You must decide if the PG21 lock will be kept in its original factory configuration (in "Always Armed" mode) or converted to a manual "On/Off" mode.

The PG21 is shipped from the factory with a Torsion Spring (HW1149) installed (see Figure 7, page 7) which forces the Cam Assembly (HW1187) against the PC Board switch, thus keeping the lock Armed whenever the key is removed. **If you wish to convert the lock to On/Off mode**, allowing the Cam Assembly to be moved in either position, the Torsion Spring must be disabled--disconnected from the Cam Assembly. To disable the Torsion Spring, use a small screwdriver and unhook the end of the Torsion Spring from the Cam Assembly, as illustrated in the following images: **Note:** To allow for future re-conversion, the Torsion Spring can be simply disconnected and not removed (see Fig. 3c below).

See the following three images (Figs. 3a-3c) to help you convert your PG21 from "Always Armed" to "On/Off" mode, or to restore your PG21 back to its original factory condition ("Always Armed").

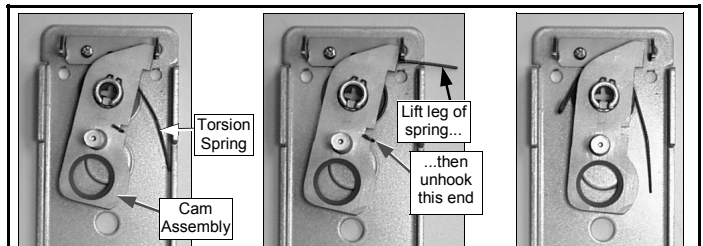

Figs. 3a-3c: Disconnect Torsion Spring from Cam Assembly:

Fig 3a displays the Torsion Spring as it is installed from the factory (thus "Always Armed" mode). To convert to "On/Off" mode, first lift leg of the Torsion Spring (Fig. 3b) from Backplate, then unhook other end of spring from Cam, releasing tension (Fig. 3c), and allowing Cam to move freely.

Jumper Configuration

Before configuring the jumpers, also see page 5 and decide which options should be selected for your application.

1. Connect the battery; a chirp will sound ensuring that power is properly connected. **Important:** Press the small CLEAR button at the lower-left corner of the circuit board (see Figure 4 below).

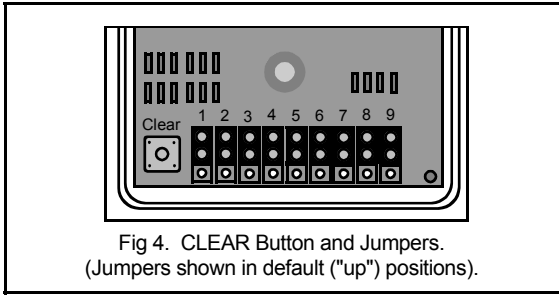

Fig 4. CLEAR Button and Jumpers.
(Jumpers shown in default ("up") positions).

2. Reed selection jumper W1 is located in the center of the PCB. The jumper should be set to the side of the unit that will have the magnet installed. (See Figure 5 below).

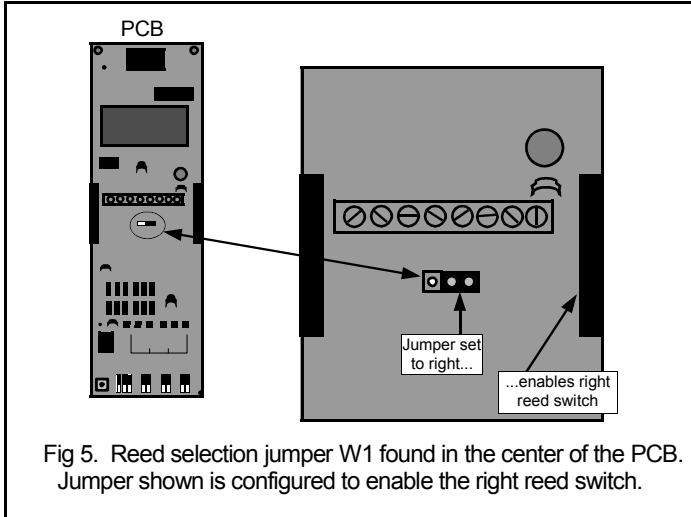

Fig 5. Reed selection jumper W1 found in the center of the PCB. Jumper shown is configured to enable the right reed switch.

3. Select jumper options (J1- J9) as follows. (Refer to the **Jumper Options** table, below and page 5).

| Jumper Options | | |
|-------------------------------|-----------------------------------------------------------|----------------------------------------------------------------|
| Jumper Number and Description | Jumper Default Position (Upper Position--see Figure 4) | Jumper Enabled Position ("Down" near edge of circuit board) |
| J1-Siren: | Sweeping | Steady |
| J2-Siren Pulsing: | Disable | Enable |
| J3-Siren 2-Minute Timeout: | Enable | Disable |
| J4-Security Level: | High/Latching | Low/Non-Latching |
| J5-Arming Delay: | No Arming Delay | 15 Seconds |
| J6-Alarm Delay 15 Sec.: | Disabled | Enabled* |
| J7-Alarm Long Delay 60 Sec.: | Disabled | Enabled* |
| J8-Annunciator (Beep): | Disabled | Enabled |
| J9-Annunciator Volume: | Low Volume | High Volume |

*NOTE: If Jumpers 6 and 7 are both enabled, Alarm Delay = 2 minutes

Important: The jumpers are only read at startup and whenever the unit is armed. If the jumpers are changed after power up, the unit must be rearmed before the jumper changes take effect. In addition, the unit will not function unless Tamper Screw (SC543) is in place.

- J1: Siren.** Factory default sound is a Sweeping Siren. Jumper moved to the "lower" position (near the edge of the circuit board) produces a Steady-Tone Siren.
- J2: Pulsing Siren.** Default setting is Constant-ON. Jumper moved to the "lower" position produces a siren that "pulses" on and off.
- J3: Siren 2-Minute Timeout.** Default setting (jumper at "upper" position) enables the timeout, allowing the siren to turn off two minutes after the alarm is tripped--if

door is closed within that two minute period. Jumper moved to the "lower" position disables the timeout, keeping the siren on until manually reset. To indicate that an alarm has occurred (Alarm Memory), the LED will start flashing. Alarm Memory is cleared after approximately 4 hours or by rotating the lock cylinder counter-clockwise and removing the key. **Note:** If the door is still open after two minutes, the alarm will restart.

- J4: Security Level.** Default setting (jumper at "upper" position--High Security) enables a latching alarm when tripped--siren remains on for 2 minutes or until turned off by the key (turn key to the left). Jumper moved to the "lower" position will set the lower security non-latching "Door Ajar" alarm mode--siren turns on when door is open, and turns off (and resets) when door is closed.

Jumpers 5-7: These jumpers are used for doors that are intended for authorized entry and exit, providing an "Arming/Exit" delay time when exiting, and an "Alarm/Entry" delay time when entering. Disarming with the key within the programmed time will prevent an alarm. See descriptions for J5 and J6 below for specific examples. **Note:** If jumpers J6 and J7 are both moved to the "lower" position, the result is a delay of 2 minutes.

- J5: Arming/Exit Delay.** Default (jumper at "upper" position) provides no Arming/Exit Delay. Jumper moved to the "lower" position enables a fixed 15-second "Arming/Exit Delay", allowing exit without alarm (i.e. the time between turning the key to the left and when the system actually arms). For example, if J5 is at the "lower" position, the protected door can be used as an "exit door"---first, insert and turn metal key to the left, then open door, exit, and let the door close. When the delay expires, the PG21 re-arms.

- J6: Alarm/Entry Delay.** Default (jumper at "upper" position) provides no delay. Jumper moved to the "lower" position (near the edge of the circuit board) provides 15 seconds of Arming Delay time. If jumpers J6 and J7 are both enabled, the result is an Alarm Delay of 2 minutes. For example, if J6 is at the "lower" position, the protected door can be used as an "entry door"--- first, open the door from the outside, insert and turn metal key to the left, and let the door close. When the delay expires, the PG21 re-arms.

- J7: Alarm/Entry Long Delay.** Default (jumper at "upper" position) provides no delay. Jumper moved to the "lower" position selects 60 seconds of Arming Delay time. If jumpers J6 and J7 are both moved to the "lower" position, the result is an Alarm Delay of 2 minutes.

- J8: Annunciator.** The annunciator provides a 1 second "beep" sound. The jumper in the factory default position (jumper at "upper" position) disables the "beep". Jumper moved to the "lower" position selects the "beep" sound when the door is closed and unit is disarmed. **Note:** This jumper selection will operate only if the PG21 is mechanically configured to "On/Off" mode (see page 2, Section "C", "**CONFIGURATION**").

- J9: Annunciator Volume.** The jumper in the factory default position (jumper at "upper" position) produces a low volume beep. Jumper moved to the "lower" position (near the edge of the circuit board) produces a high volume beep.

D. MOUNTING

Before mounting, install a mortise cylinder into the Housing Cover (H354-28) as follows:

1. Referring to the Figure 5 at right,
 - (a) install mortise cylinder (Alarm Lock Model CEM, optional) into the Housing Cover from the outside with the key slot at the 6 o'clock position;
 - (b) install the Locking Arm (HW1154). Be sure to route the strobe wire under the Locking Arm to avoid interference (see Fig 5b), then screw the Lock Ring (P1267) onto the Cylinder as shown and tighten using the Spanner Wrench (P4577) supplied.

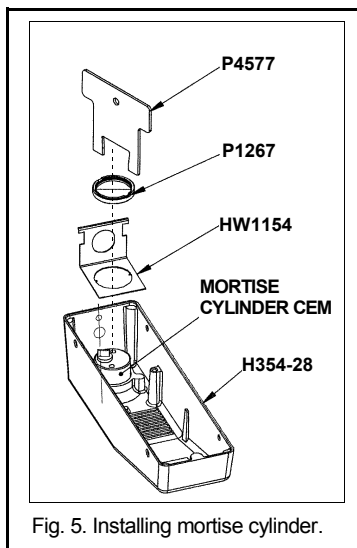

Fig. 5. Installing mortise cylinder.

2. Install the Housing Cover into the Baseplate as follows: Remove all keys from cylinder (thus ensuring the cylinder is in a 12:00 position). Holding the Housing Cover vertically with the inside facing toward you (the PC board and jumpers can be seen at bottom), *slide the switch to the right*. (**Note:** Each time the Housing Cover is removed, the switch **MUST** be moved to the right before mounting). Disconnect and reconnect the battery and press the "Clear" button (see Fig. 4). Hook the Housing Cover into the clip at the bottom of the Baseplate, then gently snap the top of the Housing cover into the top of the Baseplate. **DO NOT FORCE.** **Note:** If the switch is in the wrong position (not moved to the right), or if a key is accidentally left inside the cylinder, the Housing Cover is specifically designed NOT to lock into the Baseplate.

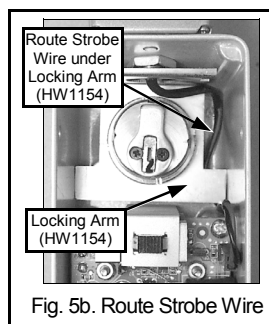

Fig. 5b. Route Strobe Wire

Important: If the unit has been installed with the aid of the template or stickers on the side of the Housing Cover, secure the Housing Cover to the Baseplate using the four #8-32 oval-head screws (supplied) and go to step 3. Be sure to install the longer "Tamper Screw" into the correct location (see page 7 Exploded View). If template or stickers are not available, do not install the longer "Tamper Screw" until the magnet has been aligned using the "Magnet Alignment Mode" as follows:

Magnet Alignment Mode

(**Note:** This mode is designed to function only after the "Clear" button is pressed—and ends once the Tamper Screw is installed). The template and stickers should be sufficient to determine the correct location of the Magnetic Actuator. If the unit has been installed with the aid of the template, proceed to step 3. If labels and templates are missing, use the following procedure:

Tamper Switch

Inside the PG21 is a Tamper Switch, and the longest of the 4 screws which secure the Housing Cover to the Baseplate is the Tamper Screw. When installed, the Tamper Screw closes the Tamper Switch, and the state of the PG21 changes from "Magnet Alignment Mode" (switch open) to normal "Standby Mode" (switch closed). Therefore, when performing Magnet Alignment Mode, do **not** install the tamper screw until the

magnet has been aligned and secured as follows:

- (a) Place the Magnetic Actuator against the wall, adjacent to the bottom of the unit. Slowly slide the Magnetic Actuator upward. The LED will turn on, indicating closure of the reed switch, then turn off. Mark the door jamb at the bottom of the Actuator. (**Note:** Sliding the Actuator still further will cause the LED to light again; ignore subsequent indications).
 - (b) Similarly, place the Magnetic Actuator against the wall, adjacent to the top of the unit. Slowly slide the Magnetic Actuator downward. The LED will turn on, then turn off once again. Mark the doorjamb at the top of the Magnetic Actuator.
3. Install the Magnetic Actuator (Part #P0290) so that it is centered between the two marks on the Housing Cover sticker, the template, or created during Magnet Alignment Mode. Mark holes, use a 1/8" (0.125") bit, and drill the hole 1" deep. Use the two supplied #8 sheet-metal screws (1"). **Note:** On steel frames, it is sometimes necessary to install a non-magnetic shim or spacer between the magnetic actuator and the frame. This is to prevent the steel frame from absorbing the magnet's magnetic field, which could cause a constant or occasional false alarm condition, and to correct for height differences between the door and the doorjamb. Use the enclosed spacers or construct a shim 1/2" x 2 1/2" x 1/8" from thick non-magnetic material such as plastic, bakelite or rubber. **Note:** The reed selection jumper W1 should be set to the side of the unit that will have the magnet installed (see Figure 5). After the Magnetic Actuator has been aligned and mounted, the Tamper Screw may be installed. This will place the unit in its normal "Standby Mode", ready for use.

REMOVING UNIT

Remove the PG21 Cover from the Baseplate as follows:

1. Remove the three #8-32 screws (SC542) and the #8-32 Tamper Screw (SC543).
2. Push the Cast Housing Cover (H354-28) against its mounting location (door or wall).
3. Insert key into mortise cylinder, push key and turn counter-clockwise.
4. Turning key counter-clockwise will cause the Housing Cover to unlatch from the top of the Baseplate (9HW1146ASSY). Finally, unlatch the Housing Cover from the bottom of the Baseplate. Remember to slide the switch to the right to prepare for re-installation.

E. FIELD TEST

1. With the unit armed and indicator status RED, close door. A brief tone will sound indicating that the unit is armed. **Note:** Unit will not arm unless the magnet (P0290) is aligned with the reed switch selected.
2. Open the door and a siren alarm should sound (if no delays are set, see options).
3. To reset the alarm, turn key fully counter-clockwise to disarm. If the PG21 lock is kept in its original factory configuration (in "Always Armed" mode), removal of the key will return the unit to armed status. If "On/Off" mode was selected, the unit will remain in disarmed mode until you remove the key by returning the key position to the center.

Low Battery

In normal operation, whether armed or disarmed, battery status is automatically checked every 4 hours—with each check, the LED will blink. When the battery becomes weak, the unit will chirp and the LED will flash about once every minute, indicating the need for battery replacement.

CONFIGURATION EXAMPLES

Use the PG21 for a variety of applications—emergency fire escape doors, nursing home stairwell doors, rear restaurant doors, and many others. To change the way the PG21 operates when in use, two areas of the PG21 can be configured: (a) the PC Board jumpers and (b) the Torsion Spring connection. Listed below are pre-defined modes for typical applications. Simply select a mode, configure the jumpers and/or spring, and put your PG21 into use. **NOTE:** "Always Armed" mode (Torsion Spring connected—factory default) is in effect unless otherwise stated.

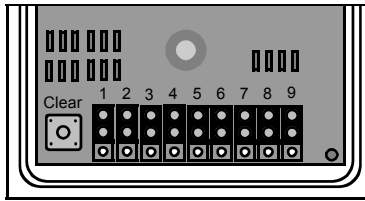

Fig. 6. Jumper Positions. Jumpers 1-9 shown in factory default positions—all jumpers "up".

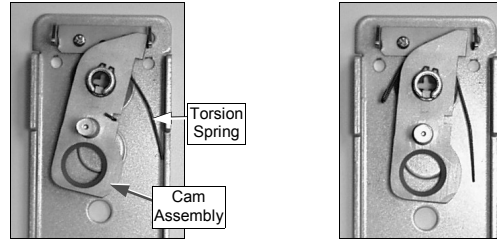



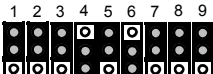
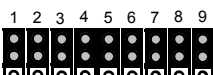
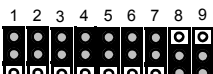

Fig. 7. Torsion Spring connected—"Always Armed" mode (left) and disconnected—"On/Off" mode (right). See **CONFIGURATION** on page 2

| MODE NAME | FEATURE DETAILS | JUMPER POSITIONS |
|----------------------------------------------------------------------------------------------------------------------------------------|--------------------------------------------------------------------------------------------------------------------------------------------------------------------------------------------------------------------------------------------------------------------------------------------------------------------------------------------------------------------------------------------------------------------------------------------------------------------------------------------------------------------------------------------------------------------------|------------------------------------------------------------------------------------------------------------|
| Factory Default Highest Security Fire/Emergency Exit Door Nursing Home Stairwell Door Delivery Door--Latching Alarm | Opening door without key while armed causes a latching alarm (key required to silence). Key required to exit and to turn off siren after an alarm. Alarm siren time-out: 2 minutes. After time-out, LED flashes. Door can be propped open indefinitely, as follows: Turn key to the left while opening door (this avoids alarm). After door is opened, release key. Door can be left open indefinitely. When door closes, door rearms (with a beep). | All Jumpers Up |
| Entry/Exit Door with Key Needed | Key required to enter and exit—but door must be closed within selected time or alarm occurs. Key required to turn off siren after an alarm. Opening door without key while armed causes a latching alarm after set delay time. Alarm siren time-out: 2 minutes. After time-out, LED flashes. Add a delay so you can enter or exit without an alarm: Add Arming/Exit Delay of 15 seconds: J5 down only Add Alarm/Entry Delay of 15 secs: J6 down Add Alarm/Entry Delay of 1 minute J6 up, J7 down Add Alarm/Entry Delay of 2 mins J6 & J7 down | Example shown: J5 down--15 second Arming/Exit Delay J6 down--15 second Alarm/Entry Delay |
| Delivery Mode Delivery Door--Non-Latching Alarm Exit Door with Instant Alarm--No Key needed to silence | Instant non-latching alarm when door is opened, siren turns off and alarm resets when door is closed. For delivery, turn key to left, open door and prop door open; auto-rearms when the door closes. | J4 down |
| 2-Minute Delivery Door with non-latching alarm Door Ajar Mode with 2 minute delay. | No key needed to open door without alarm, but if door is left open more than 2 minutes, alarm sounds. No key needed to silence, just close door. Allows door to remain open up to 2 minutes without an alarm. | J4, J6 and J7 all down |

continued

CONFIGURATION EXAMPLES (cont'd)

| MODE NAME | FEATURE DETAILS | JUMPER POSITIONS |
|-----------------------------------------------------------------------------------------------------|-------------------------------------------------------------------------------------------------------------------------------------------------------------------------------------------------------------------------------------------------------------------------------------------------------------------------------------------------------------------------------------------------------------------------------------------------------------------------------------------------------------------------------------------------------------------------------------------------------------------------------------------|-----------------------------------------------------------------------------------------------------------------------------------------------------------------------------------------------------------------------------------------------------------------------------------------------------------------------------------------------------------------------------------------------------------------------|
| For Multiple Door Installations | <p>A PG21 installed on several doors each with its unique siren sound. Four siren sounds: Sweep, Pulsing Sweep, Steady, Pulsing Steady. Set a different siren sound for each door in order to easily identify which door has been accessed. Jumpers 1 and 2 are configured.</p> | <p>Sweep </p> <p>Pulsing Sweep </p> <p>Steady </p> <p>Pulsing Steady </p> |
| Door Ajar Mode Exit/Entry Door without Key Needed No Key Passage Mode Friendly Mode | <p>You can enter or exit without key. Door can remain open without alarm for length of delay time. If door left open past delay time, siren will sound until door is closed.</p> <p>Closing door turns siren off and rearms (no key required--just close door).</p> <p>Auto re-arming does not sound a chirp.</p> <p>Add a delay so you can enter or exit without an alarm: Add Arming/Exit Delay of 15 seconds: J5 down only Add Alarm/Entry Delay of 15 secs: J6 down Add Alarm/Entry Delay of 1 minute J6 up, J7 down Add Alarm/Entry Delay of 2 mins J6 & J7 down</p> | <p>Example shown: J4 down--Non-Latching Alarm. J6 down--15 second "Passage Time/Door Open Time"</p>  |
| "On/Off" Mode Manual Arm/Disarm Door | <p>Manual Arming Mode ("On /Off" mode. See page 2, Configuration). Torsion Spring disconnected from Cam Assembly. Manually arm or disarm system for extended periods of time. No "Auto-rearm". Mechanical configuration required.</p> | <p>All Jumpers up</p>  |
| Back Door Annunciator | <p>For use only with "On/Off" mode when unit is disarmed with a key. PG21 will beep for 2 seconds when door is opened while disarmed. Jumper J9 determines volume of chirp: ("up" = low volume, "down" = high volume).</p> | <p>J8 & J9 down</p>  |

EXPLODED VIEW

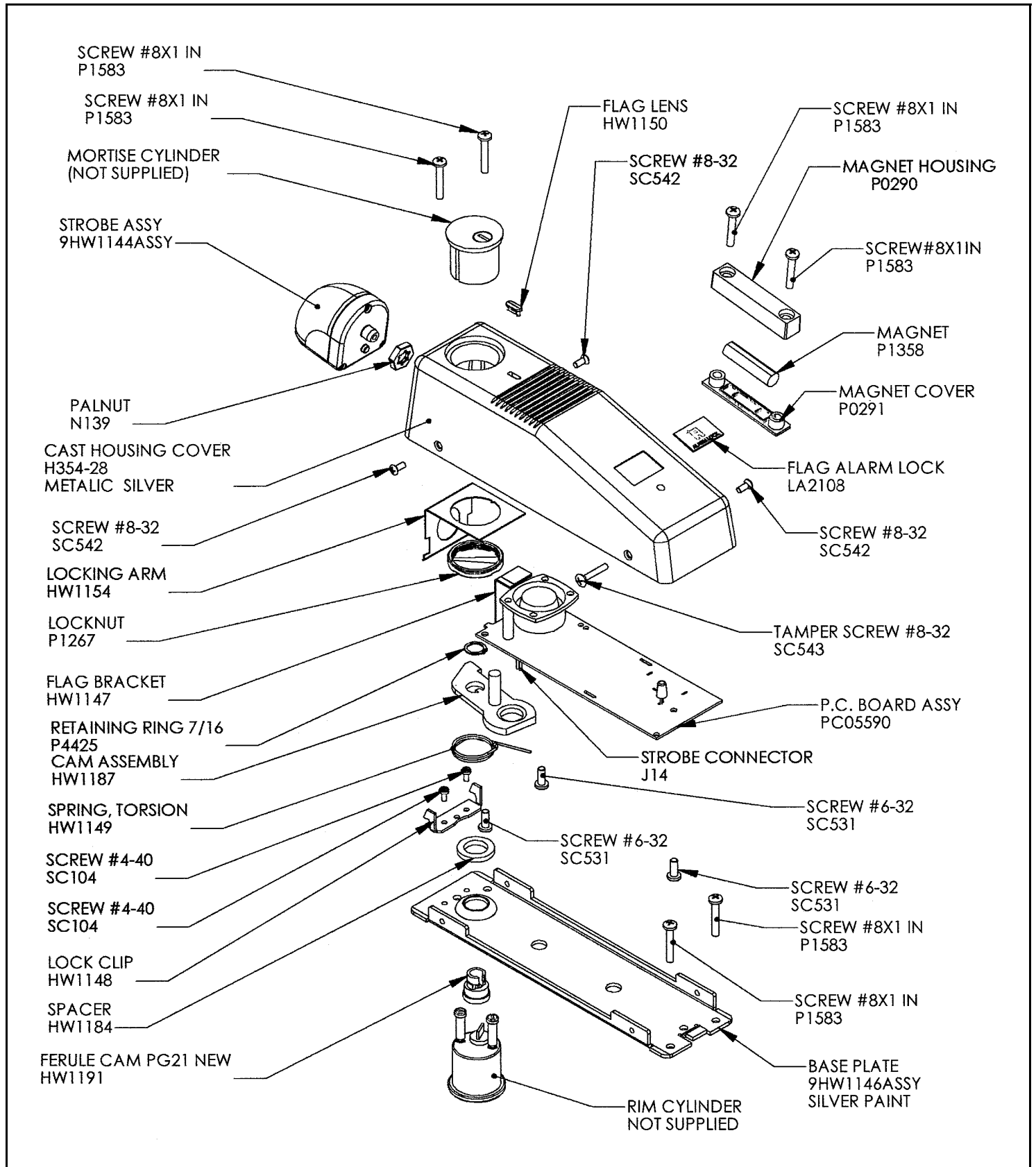

Fig. 7 Exploded view with part numbers

ALARM LOCK LIMITED WARRANTY

ALARM LOCK SECURITY SYSTEMS, INC. (ALARM LOCK) warrants its products to be free from manufacturing defects in materials and workmanship for 24 months following the date of manufacture. ALARM LOCK will, within said period, at its option, repair or replace any product failing to operate correctly without charge to the original purchaser or user.

This warranty shall not apply to any equipment, or any part thereof, which has been repaired by others, improperly installed, improperly used, abused, altered, damaged, subjected to acts of God, or on which any serial numbers have been altered, defaced or removed. Seller will not be responsible for any dismantling or reinstallation charges.

THERE ARE NO WARRANTIES, EXPRESS OR IMPLIED, WHICH EXTEND BEYOND THE DESCRIPTION ON THE FACE HEREOF. THERE IS NO EXPRESS OR IMPLIED WARRANTY OF MERCHANTABILITY OR A WARRANTY OF FITNESS FOR A PARTICULAR PURPOSE. ADDITIONALLY, THIS WARRANTY IS IN LIEU OF ALL OTHER OBLIGATIONS OR LIABILITIES ON THE PART OF ALARM LOCK.

Any action for breach of warranty, including but not limited to any implied warranty of merchantability, must be brought within the six months following the end of the warranty period.

IN NO CASE SHALL ALARM LOCK BE LIABLE TO ANYONE FOR ANY CONSEQUENTIAL OR INCIDENTAL DAMAGES FOR BREACH OF THIS OR ANY OTHER WARRANTY, EXPRESS OR IMPLIED, EVEN IF THE LOSS OR DAMAGE IS CAUSED BY THE SELLER'S OWN NEGLIGENCE OR FAULT.

In case of defect, contact the security professional who installed and maintains your security system. In order to exercise the warranty, the product must be returned by the security professional, shipping costs prepaid and insured to ALARM LOCK. After repair or replacement, ALARM LOCK assumes the cost of returning products under warranty. ALARM LOCK shall have no obligation under this warranty, or otherwise, if the product has been repaired by others, improperly installed, improperly used, abused, altered, damaged, subjected to accident, nuisance, flood, fire or acts of God, or on which any serial numbers have been altered, defaced or removed. ALARM LOCK will not be responsible for any dismantling, reassembly or reinstallation charges.

This warranty contains the entire warranty. It is the sole warranty and any prior agreements or representations, whether oral or written, are either merged herein or are expressly canceled. ALARM LOCK neither assumes, nor authorizes any other person purporting to act on its behalf to modify, to change, or to assume for it, any other warranty or liability concerning its products.

In no event shall ALARM LOCK be liable for an amount in excess of ALARM LOCK's original selling price of the product, for any loss or damage, whether direct, indirect, incidental, consequential, or otherwise arising out of any failure of the product. Seller's warranty, as hereinabove set forth, shall not be enlarged, diminished or affected by and no obligation or liability shall arise or grow out of Seller's rendering of technical advice or service in connection with Buyer's order of the goods furnished hereunder.

ALARM LOCK RECOMMENDS THAT THE ENTIRE SYSTEM BE COMPLETELY TESTED WEEKLY.

Warning: Despite frequent testing, and due to, but not limited to, any or all of the following; criminal tampering, electrical or communications disruption, it is possible for the system to fail to perform as expected. ALARM LOCK does not represent that the product/system may not be compromised or circumvented; or that the product or system will prevent any personal injury or property loss by burglary, robbery, fire or otherwise; nor that the product or system will in all cases provide adequate warning or protection. A properly installed and maintained alarm may only reduce risk of burglary, robbery, fire or otherwise but it is not insurance or a guarantee that these events will not occur. CONSEQUENTLY, SELLER SHALL HAVE NO LIABILITY FOR ANY PERSONAL INJURY, PROPERTY DAMAGE, OR OTHER LOSS BASED ON A CLAIM THE PRODUCT FAILED TO GIVE WARNING. Therefore, the installer should in turn advise the consumer to take any and all precautions for his or her safety including, but not limited to, fleeing the premises and calling police or fire department, in order to mitigate the possibilities of harm and/or damage.

ALARM LOCK is not an insurer of either the property or safety of the user's family or employees, and limits its liability for any loss or damage including incidental or consequential damages to ALARM LOCK's original selling price of the product regardless of the cause of such loss or damage.

Some states do not allow limitations on how long an implied warranty lasts or do not allow the exclusion or limitation of incidental or consequential damages, or differentiate in their treatment of limitations of liability for ordinary or gross negligence, so the above limitations or exclusions may not apply to you. This Warranty gives you specific legal rights and you may also have other rights which vary from state to state.